

Manuale di istruzioni

Dolphin FLIPPER 2X2



IT Istruzioni per l'uso

EN

Dolphin 2x2 Gyro Robotic Pool Cleaner

Operating Instructions

Contents

1. INTRODUCTION	2
2. SPECIFICATIONS	2
3. WARNINGS AND CAUTIONS	2
3.1. Warnings	2
3.2. Cautions	2
4. POOL CLEANER PARTS	3
5. USING THE POOL CLEANER	4
5.1. Setup	4
5.2. Putting the Pool Cleaner into the pool	5
5.3. Removing the Pool Cleaner from the pool	5
5.4. Maintenance	6
5.5. Off-season storage	7
6. POWER SUPPLY	8
7. REMOTE CONTROL UNIT	9

Dolphin 2x2 Gyro Pool Cleaner

Operating Instructions

1. INTRODUCTION

Thank you for purchasing a Maytronics Robotic Pool Cleaner.

We are sure that your Maytronics Robotic Pool Cleaner will provide you with reliable, convenient and cost effective pool cleaning. Its reliable filtration in all pool conditions and all-surface climbing brush enhance maximum pool hygiene.

The Robotic Pool Cleaners by Maytronics deliver advanced cleaning technologies, long lasting performance and easy maintenance.

2. SPECIFICATIONS

Motor protection: IP 68

Minimum depth: 0.80m/2.6ft

Maximum depth: 5m/16.4ft

3. WARNINGS AND CAUTIONS

3.1. Warnings



- Use the originally supplied power supply only
- Ensure the electrical outlet is protected by a ground fault interrupter (GFI) or an earth leakage interrupter (ELI)
- Keep the power supply out of standing water
- Position the power supply at least 3m/10ft away from the edge of the pool
- Do not enter the pool while the pool cleaner is working
- Unplug the power supply before servicing

3.2. Cautions

When not in use store the Pool Cleaner on the Caddy in a shaded area.

Use the Pool Cleaner in the following water conditions only:

Chlorine	Max 4 ppm
pH	7.0 - 7.8
Temperature	6 – 34°C (43-93°F)
NaCl	Maximum = 5000 ppm

4. POOL CLEANER PARTS

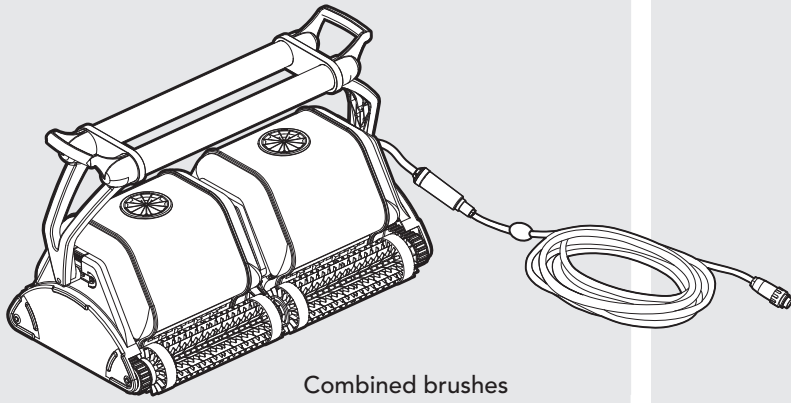

Combined brushes
All surface climbing brushes
ideal for most pool surfaces

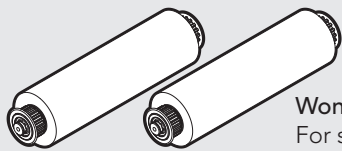

(Optional)

Wonder (foam) brushes
For smooth ceramic

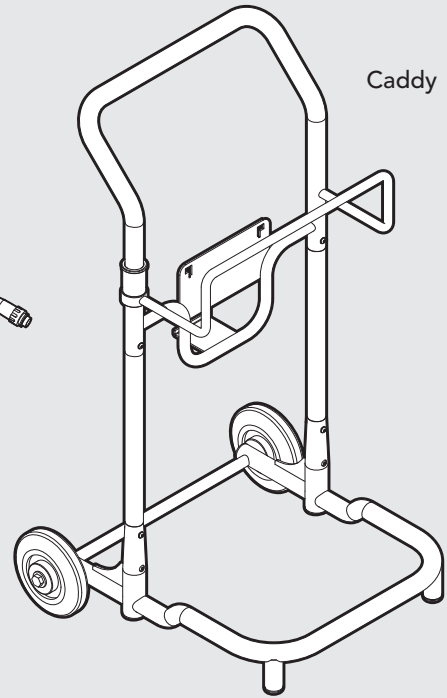

Caddy

Bottom lid and filter bags

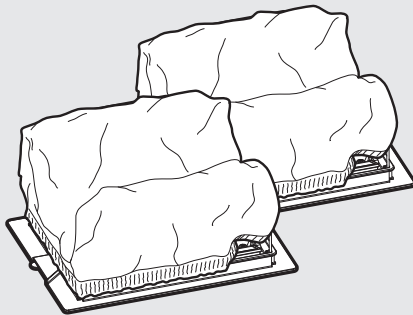

Filter bags options:
Fine - default
Ultra fine - extra



Remote control unit

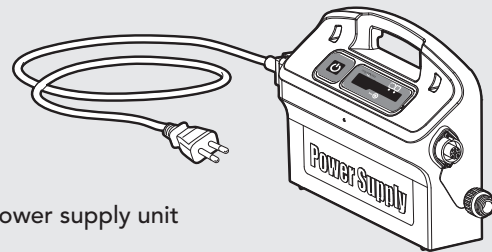

Power supply unit

5. USING THE POOL CLEANER

5.1. Set Up

Position the power supply so that it is approximately in the middle of the long side of the pool at a distance of 3m/10ft.

Attach the floating cable to the power supply by inserting it with the notch on the connector (1) lined up with the groove in the socket on the power supply and turning clockwise (2).

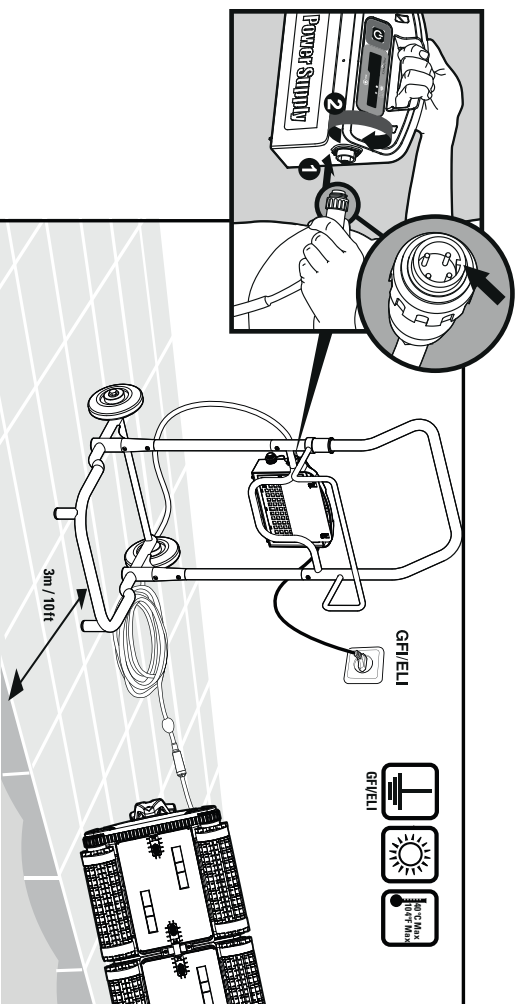

Change diagonal handle position for water line sideways movement. To adjust the handle angle:

- A.** Press the latch down and hold it in position.
- B.** Move the handle to the desired position and release the latch to hold the handle in place.

1 - 2 Normal advance
More efficient cleaning action on water-line.

3 - 4 Fast advance
Fast speed – for faster but less efficient cleaning action on water-line.

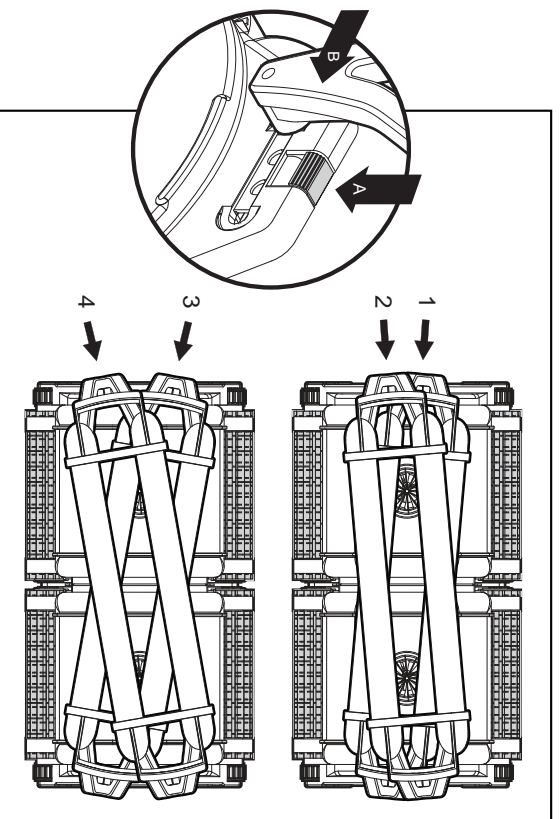

5.2. Putting the Pool Cleaner into the pool

If Wonder brush/ Wonder rings are dry, soak them in water until soft.

Shake the robot from side to side or turn it upside down to release trapped air.

Let it sink to the pool floor.

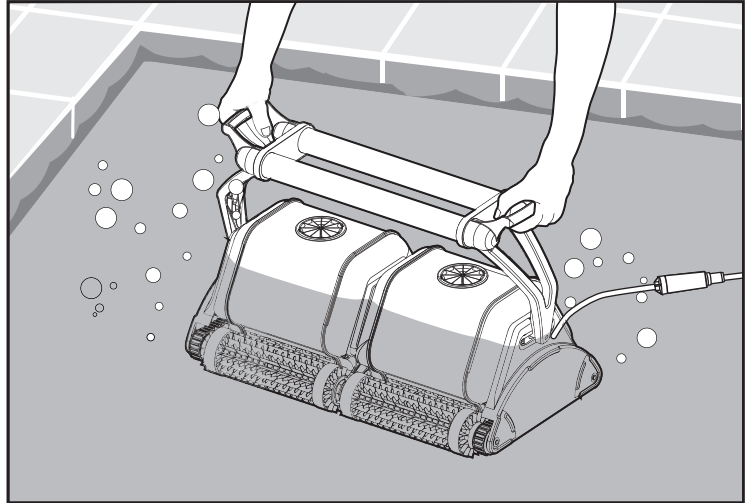

Turn the power supply ON.

The Pool Cleaner will now operate until it has reached the end of the cleaning cycle.

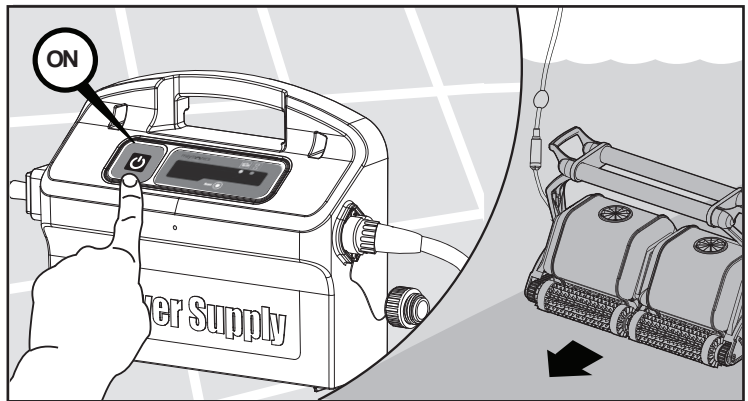

5.3. Removing the Pool Cleaner from the pool

The robot will perform automatic shut-off at the end of the cleaning cycle.

 Turn OFF and unplug the power supply.

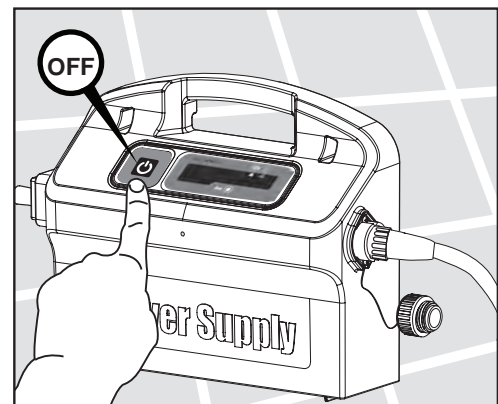

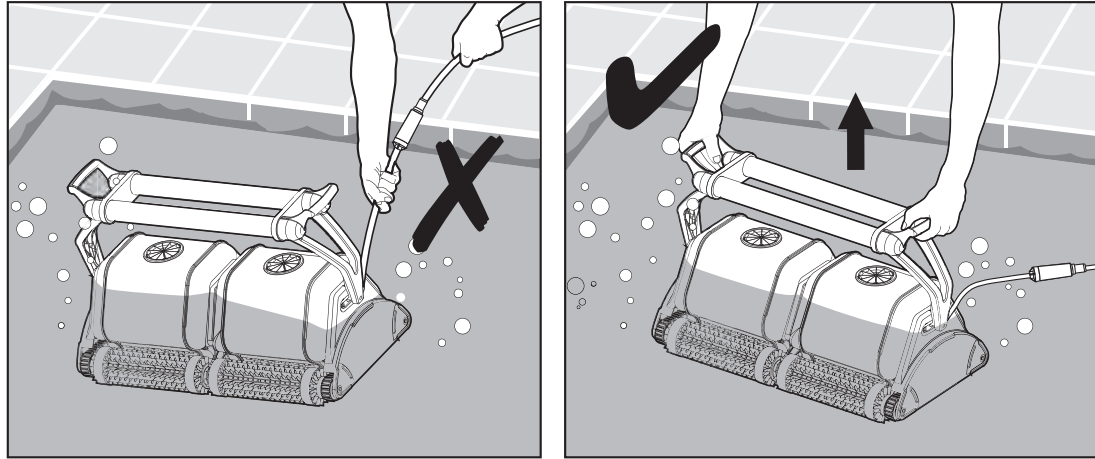

Using the floating cable, bring the Pool Cleaner to the pool's edge.
 Using the handle remove the Pool Cleaner from the pool.

! DO NOT PULL THE POOL CLEANER FROM THE POOL USING THE CABLE.

5.4. Maintenance

Clean the filter bags with a hose.
 Periodically clean the brushes with a hose.
 It is recommended to periodically wash the filter bags in a washing machine.
 Use gentle cycle program.

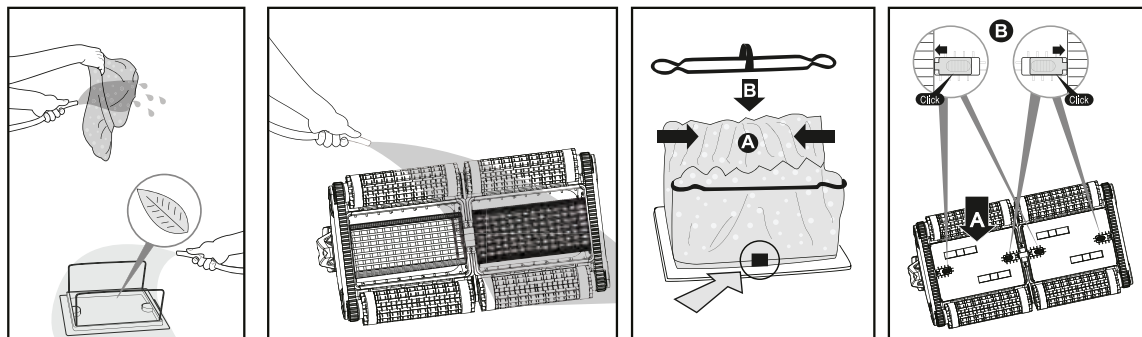
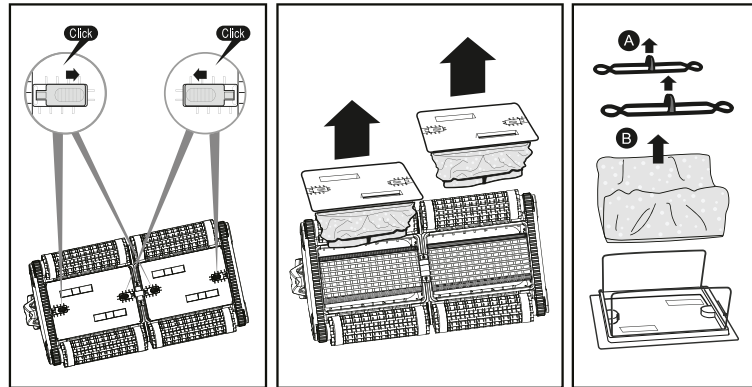

Cleaning the impeller

 **Unplug the power supply.**

If you notice debris trapped in the impeller open the impeller and remove the debris.

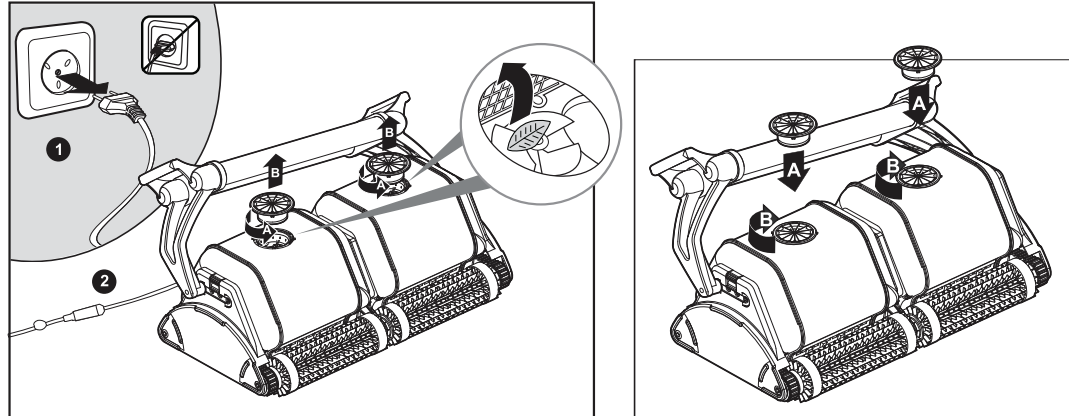

Cable

To remove the kinks, stretch the cable out completely and let it sit for at least a day in the sun.

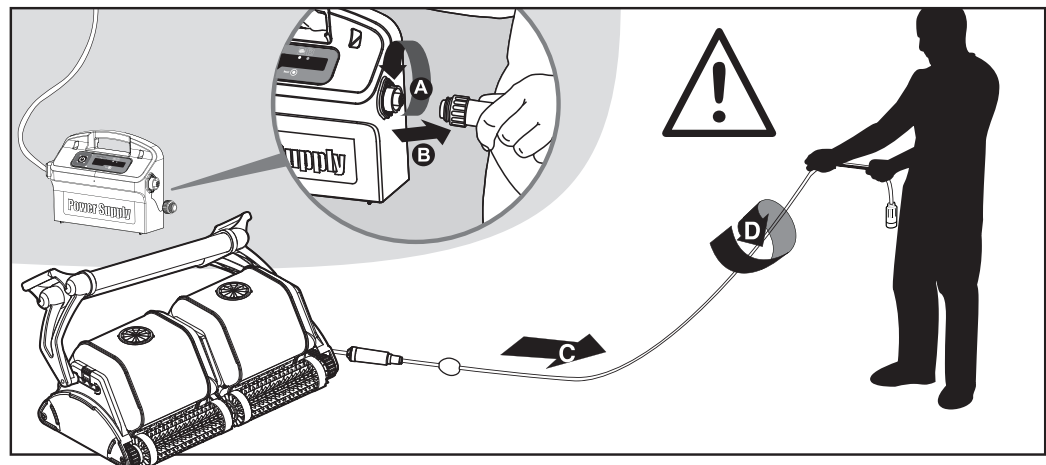

5.5. Off-season storage

If the pool cleaner will not be in use for an extended period, perform the following storage steps:

- Make sure that no water is left in the pool cleaner
- Thoroughly clean the filter bags and insert in place
- Roll up the cable so that it has no kinks and place on the Caddy
- Store the pool cleaner in a protected area either on its Caddy or simply upsidedown

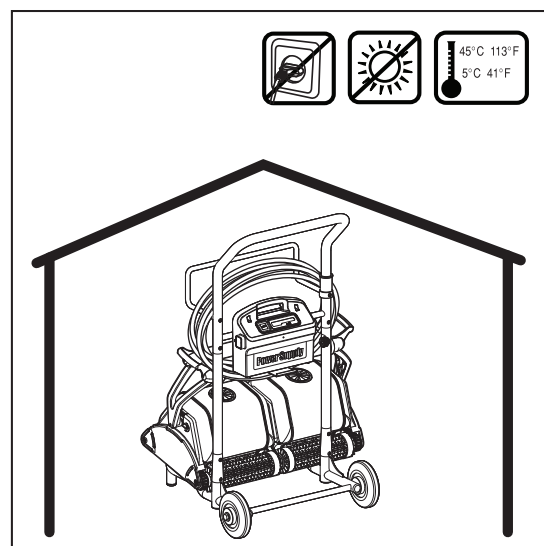

6. POWER SUPPLY

Digital "Switch-Mode" Power Supply with full filter bag and delay indicator.

- Input - 100-250 AC Volts
- 50-60 Hertz
- 220 Watt
- Output - <30 VDC
- IP 54

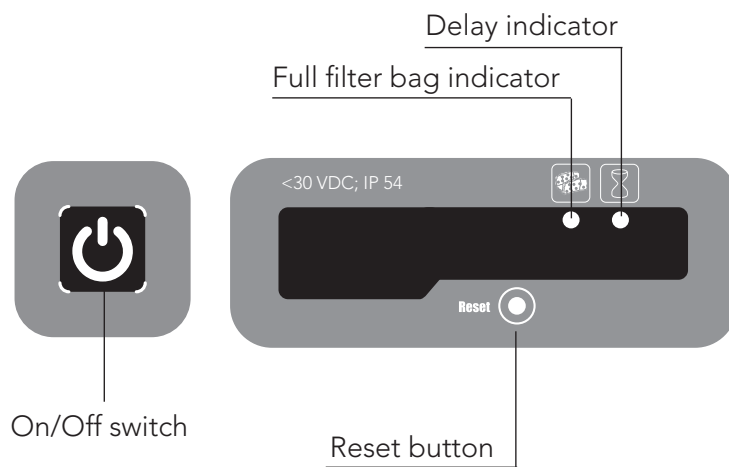
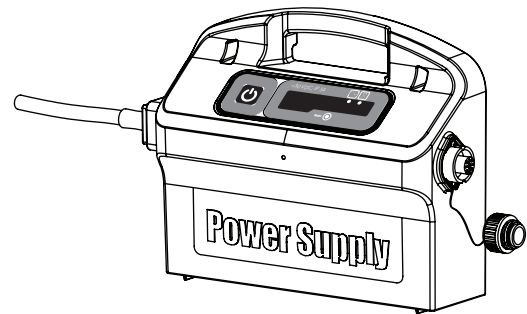

Full filter bag indicator and Reset button

The power supply is equipped with a filter bag status indicator.

The red LED indicates two filter conditions.

- When blinking - The filter is partially blocked.
- When lighted - The filter is blocked and must be emptied and cleaned.

If the LED does not turn off after the filter bag had been emptied and cleaned, press the RESET button while the robot is working.



Delay indicator

The power supply is equipped with a Delay indicator that indicates if the Delay option is activated (through the remote control unit).

7. REMOTE CONTROL UNIT

The Control Panel

The remote control unit (RCU) offers two operation modes – Automatic mode and manual direction control mode.

In automatic mode, the cleaning parameters can be changed.

In manual direction mode, the robot's motion can be controlled manually.

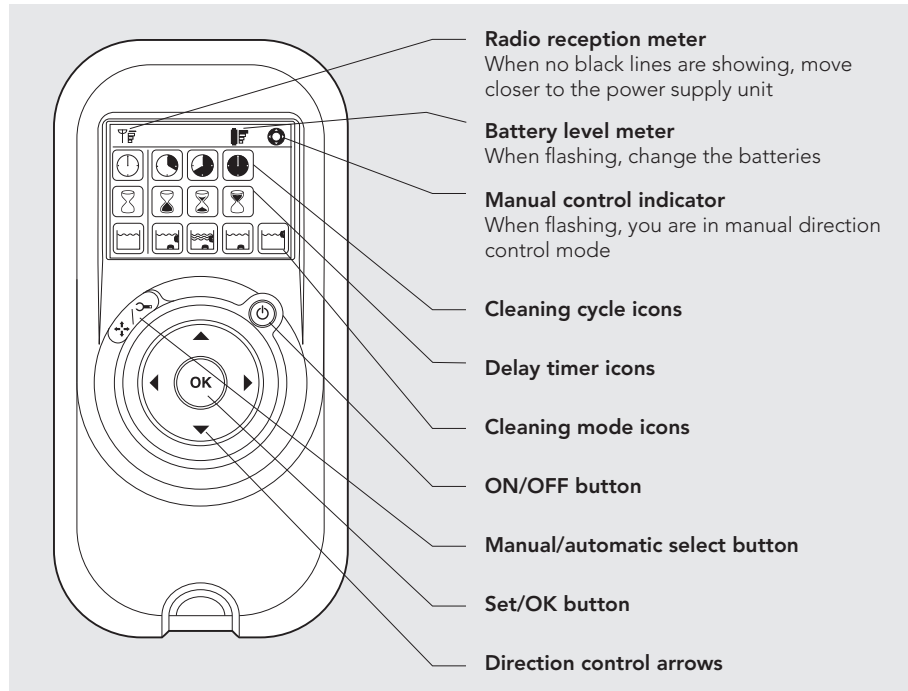

Manual Direction Control Mode

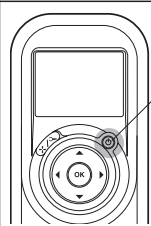

On/Off button

1. Press the On/Off button once. The remote control will start in manual direction control mode.
2. Use the direction control arrows (see right) to control the movement of the robot around the pool.

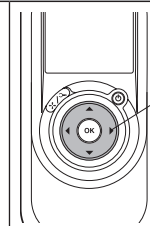

Direction control arrows

Exiting Manual Direction Control Mode and setting the Automatic Mode



Manual/Automatic Select button

1. To exit the manual direction control mode, press the Manual/Automatic select button once only.
2. The digital screen will light up and three rows of function icons will be displayed in default mode.

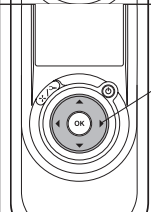
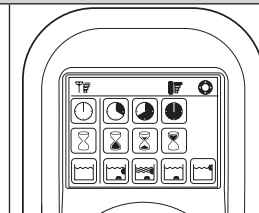





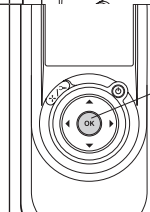







Direction control arrows

1. To change the parameters press the up or down arrows.
2. To select the parameter settings use the right or left arrows. When you reach the required function press the Set/OK button.



Set OK button

Press the Manual/Automatic select button and then choose the desired parameters according to the following table:

 <p>Cleaning cycle indicator This determines the length of the cleaning cycle.</p>	 <p>Fast 4-hour cycle</p>	 <p>Efficient 6-hour cycle for everyday use. (Default setting)</p>	 <p>Extra 8-hour cycle</p>	
 <p>Delay time indicator This determines when the pool cleaner starts to work. Delaying allows the dirt to settle to the bottom of the pool.</p>	 <p>Immediate start (Default setting)</p>	 <p>One-hour delay</p>	 <p>Two-hour delay</p>	
 <p>Cleaning action indicator Allowing you to choose from the following options.</p>	 <p>Standard Floor and wall cleaning. (Default setting)</p>	 <p>Ultra-clean Stronger suction and slower movement. (floor and wall)</p>	 <p>Floor only Cleans only the floor and the area where the floor and walls meet</p>	 <p>Walls only Cleans walls and waterline only (Except Dolphin 2x2 Gyro mode)</p>

Note:

- After 2 minute if no button is pressed, the Remote Control Unit will shut-down and the Pool cleaner will continue to work in the previous settings.
- When the "Ultra-Clean" and "Walls Only" options finish their cycles, the Pool Cleaner will return to default settings.

FR

Dolphin 2x2 Gyro nettoyeur de piscine Instructions d'opération

Contents

1. INTRODUCTION	12
2. SPECIFICATIONS	12
3. AVERTISSEMENTS ET PRECAUTIONS.....	12
3.1. Avertissements.....	12
3.2. Précautions.....	12
4. ELEMENTS DU NETTOYEUR DE PISCINE	13
5. UTILISATION DU NETTOYEUR DE PISCINE	14
5.1. Montage	14
5.2. Introduction du nettoyeur dans la piscine	15
5.3. Retrait du nettoyeur de la piscine	15
5.4. Entretien	16
5.5. Stockage hors saison.....	17
6. D'ALIMENTATION.....	18
7. LA TÉLÉCOMMANDE.....	19

Dolphin 2x2 Gyro nettoyeur de piscine

Instructions d'opération

1. INTRODUCTION

Merci d'avoir acheté ce robot nettoyeur de piscine de chez Maytronics.

Nous sommes convaincus que votre robot nettoyeur de piscine vous assurera un nettoyage crédible, convenable et rentable de votre piscine. Son filtrage fiable de toutes les piscines, son brossage actif et sa brosse grimpant sur toutes les surfaces permettent d'assurer l'hygiène maximale de votre piscine.

Les robots nettoyeurs de piscine de Maytronics fournissent une technologie de nettoyage avancée, une performance de longue durée et une maintenance en toute simplicité. Vous et votre famille pourrez profiter en toute confiance d'une piscine entièrement propre.

2. SPECIFICATIONS

Protection du moteur: IP 68

Profondeur minimale: 0,80m/2,6 ft

Profondeur maximale: 5m/16,4 ft

3. AVERTISSEMENTS ET PRECAUTIONS

3.1. Avertissements



- Utilisez uniquement le bloc d'alimentation électrique qui vous a été fourni à l'origine
- Assurez-vous que la prise électrique est protégée par un disjoncteur de fuite à la terre
- Eloignez le bloc d'alimentation des flaques d'eau
- Positionnez le bloc d'alimentation à au moins 3 m / 10 ft du bord de la piscine
- N'entrez pas dans la piscine lorsque le nettoyeur est en marche
- Débranchez l'alimentation électrique avant tout entretien du robot

3.2. Précautions

Lorsqu'il n'est pas utilisé, entreposez le nettoyeur de piscine sur son Caddy dans un lieu ombragé.

N'utilisez le nettoyeur de piscine que lorsque les conditions de l'eau sont les suivantes:

Chlore	Max 4 ppm
pH	7,0 - 7,8
Température	6 – 34°C (43-93°F)
NaCl	Maximum = 5000 ppm

4. ELEMENTS DU NETTOYEUR DE PISCINE

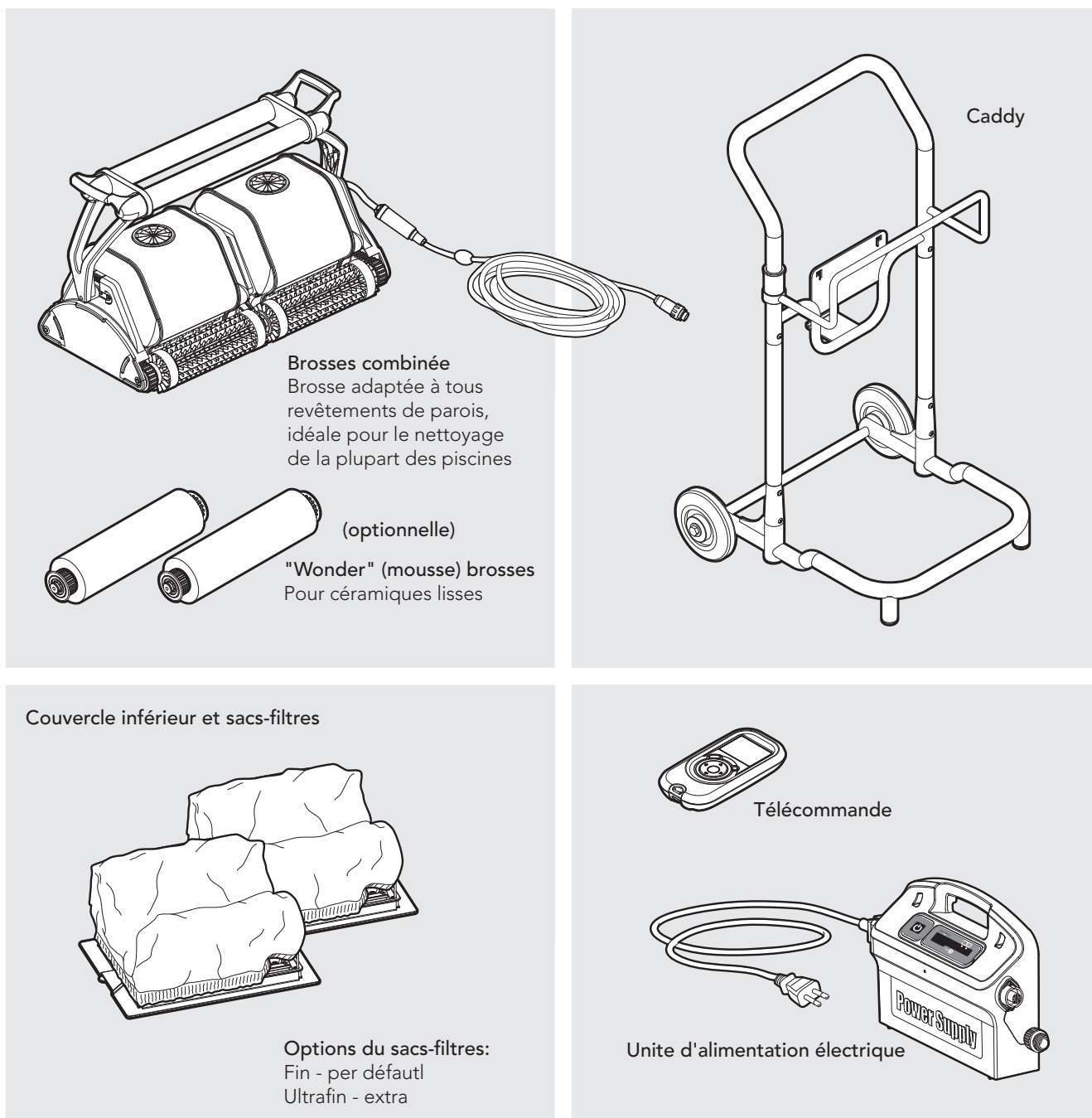

5. UTILISATION DU NETTOYEUR DE PISCINE

5.1. Montage

Positionnez le bloc d'alimentation de manière à ce qu'il soit à peu près au milieu de la longueur de la piscine à une distance de 3m/10 pieds.

Branchez le câble flottant à l'alimentation en introduisant-le à l'aide de l'encoche dans le connecteur (1) et alignez-le avec la rainure de la prise du bloc d'alimentation; ensuite, tournez dans le sens des aiguilles d'une montre (2).

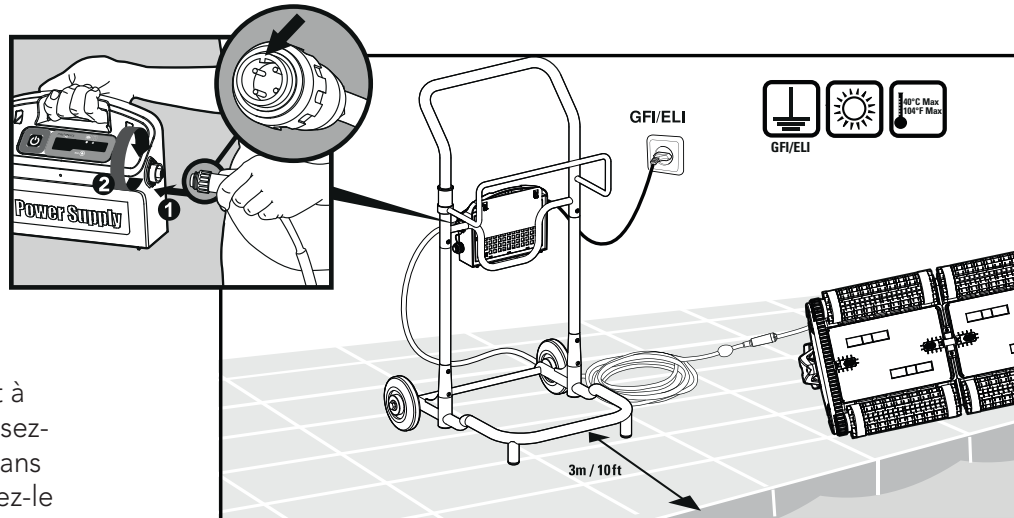

Modifiez la position diagonale de la poignée pour que le robot effectue les mouvements latéraux nécessaires au nettoyage de la bordure de l'eau.

Pour ajuster l'angle du manche:

A. Appuyez vers le bas sur le loquet et maintenez-le en position.

B. Placez le manche sur la position désirée et relâchez le loquet pour maintenir le manche en place.

1 - 2 Progression normale

pour un nettoyage plus efficace de la bordure de l'eau.

3 - 4 Progression rapide

vitesse accélérée – pour un nettoyage plus rapide mais moins appliqué de la bordure de l'eau.

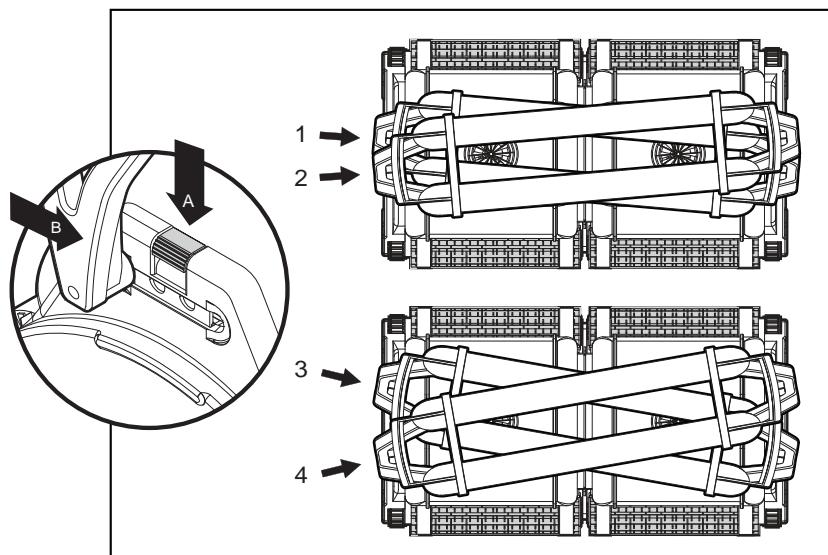

5.2. Introduction du nettoyeur dans la piscine

Si la brosse "Wonder" ou les anneaux "Wonder" sont secs, les tremper dans l'eau jusqu'à ce qu'ils deviennent souples.

Secouez le robot sur les côtés ou de haut en bas pour libérer les bulles d'air. Laissez-le couler vers le fond de la piscine.

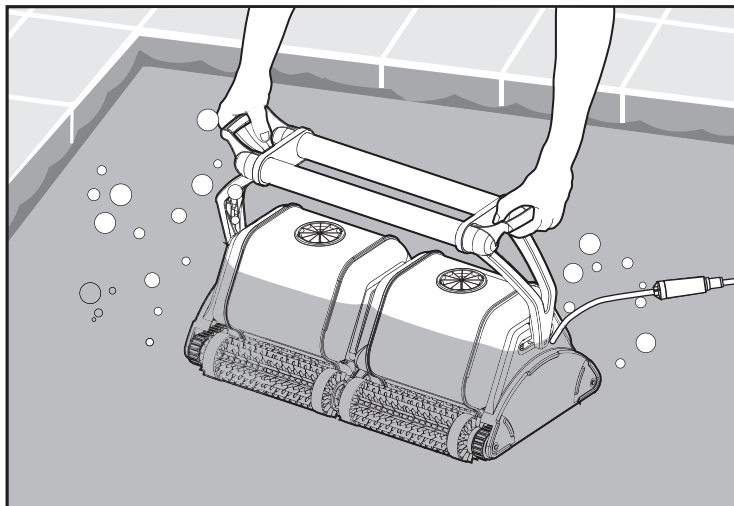

Mettez l'appareil sous tension (ON).

Le nettoyeur de piscine fonctionnera jusqu'à ce qu'il atteigne la fin du cycle de nettoyage.

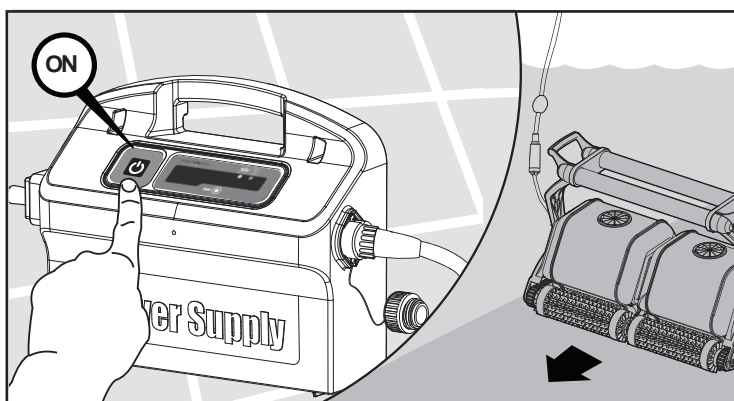

5.3. Retrait du Nettoyeur de la piscine

Le robot s'éteindra automatiquement à la fin du cycle de nettoyage.



Coupez le courant (OFF) et débranchez le bloc d'alimentation.

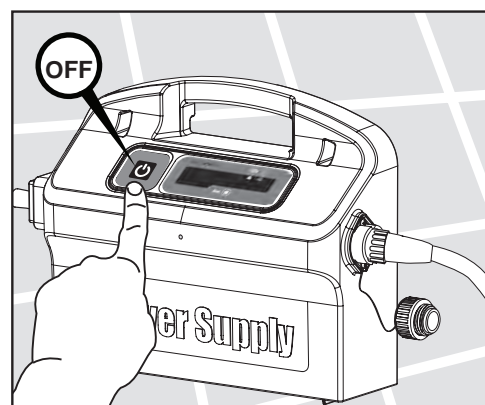

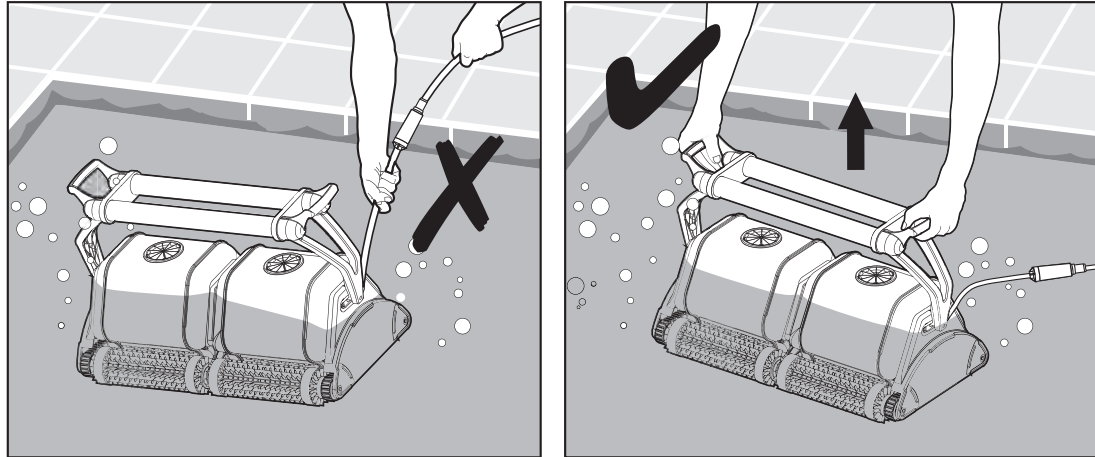

A l'aide du câble de flottaison, ramenez le Nettoyeur de Piscine au bord de la piscine.
A l'aide de la poignée, sortez le Nettoyeur de la piscine.

! NE PAS RETIRER LE NETTOYEUR DE LA PISCINE EN TIRANT SUR LE CABLE.

5.4. Entretien

Nettoyez les sacs-filtres à l'aide d'un tuyau d'eau. De temps en temps, rincez les brosses à l'aide d'un tuyau d'eau.
Il est recommandé de laver périodiquement les sacs-filtres dans la machine à laver. Utilisez le programme pour tissus délicats.

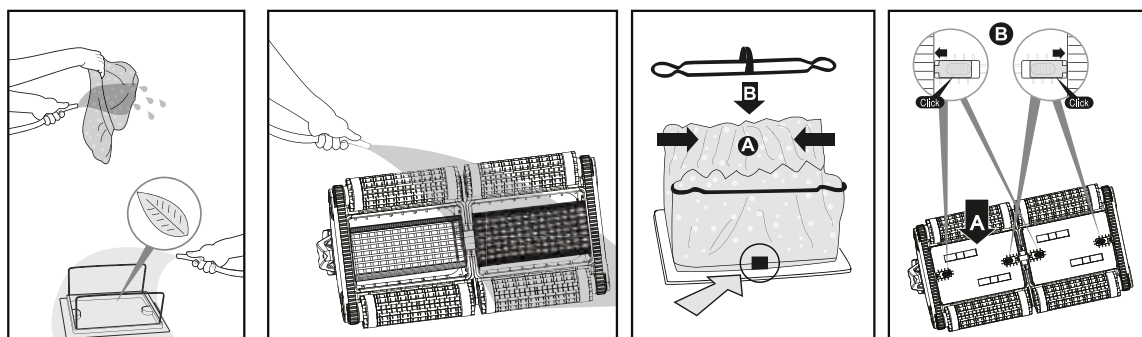
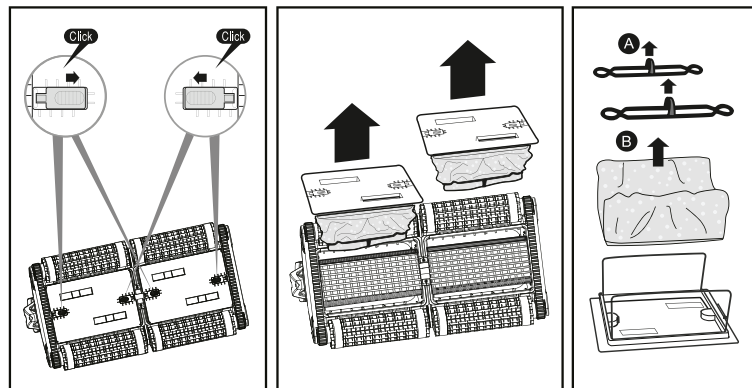

Nettoyage de l'impulseur

 Débranchez le bloc d'alimentation.

Si vous constatez l'existence de débris emprisonnés dans l'impulseur, ouvrez l'impulseur et retirez les débris.

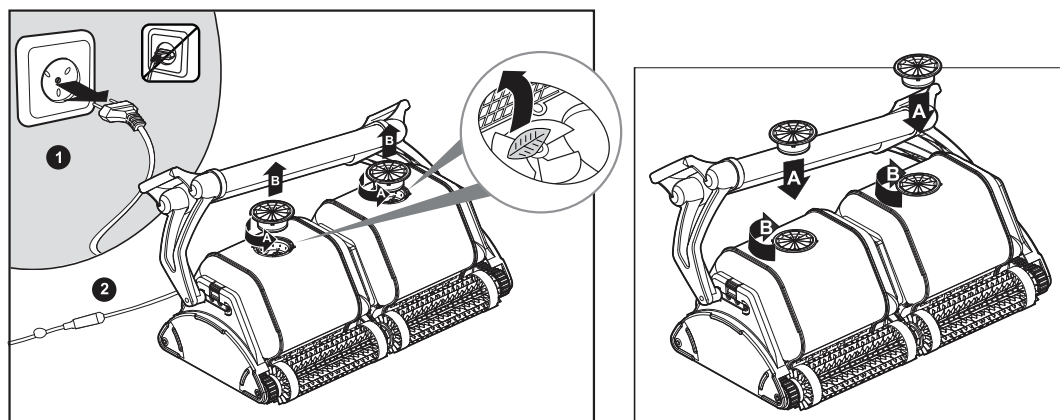

Câble

Pour éliminer les plis, tendez le câble entièrement et laissez-le au soleil pendant au moins une journée.

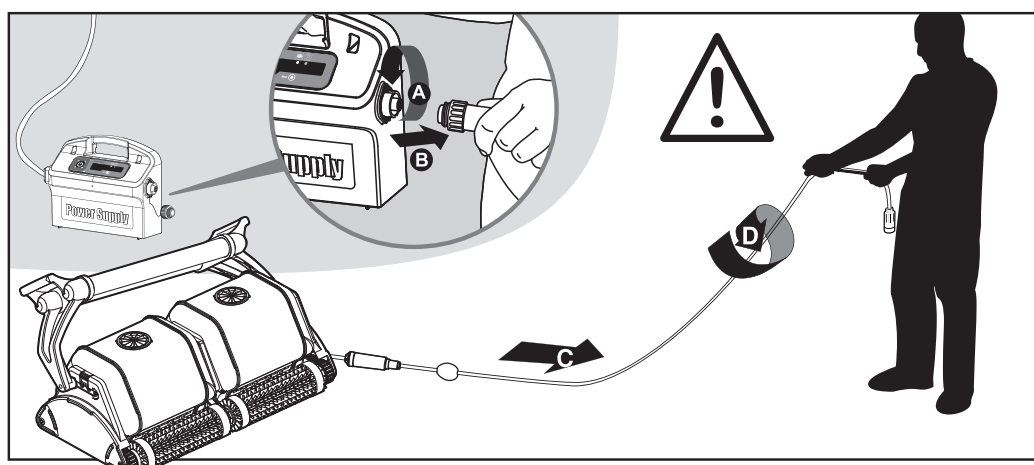

5.5. Stockage hors saison

Si le nettoyeur de piscine n'est pas utilisé pendant une période prolongée, veuillez l'entreposer de la manière suivante:

- Assurez-vous qu'il n'y a 2x2 d'eau dans le Nettoyeur de Piscine
- Nettoyez complètement les sacs-filtres et remettez-le en place
- Rembobinez le câble sans y faire de plis et placez-le sur le Caddy
- Entreposez le nettoyeur de piscine dans un endroit protégé soit sur son Caddy, soit simplement à l'envers

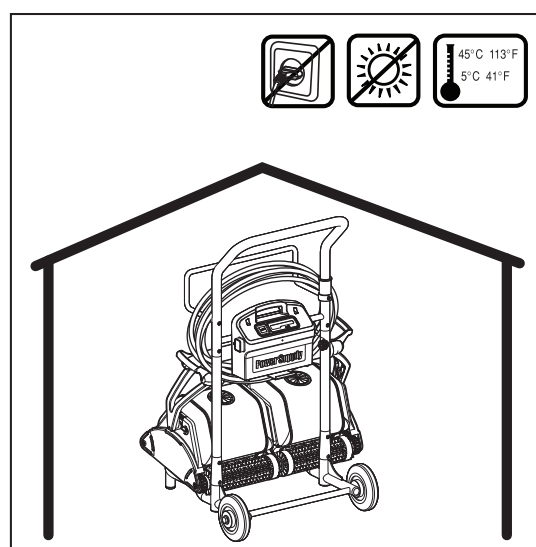

6. D'ALIMENTATION

Alimentation numérique avec « Mode Interrupteur » ("Switch-Mode") avec indicateur de sac filtre plein et de temporisation.

- Entrée - 100-250 AC Volts
- 50-60 Hertz
- 220 Watt
- Sortie - <30 VDC
- IP 54

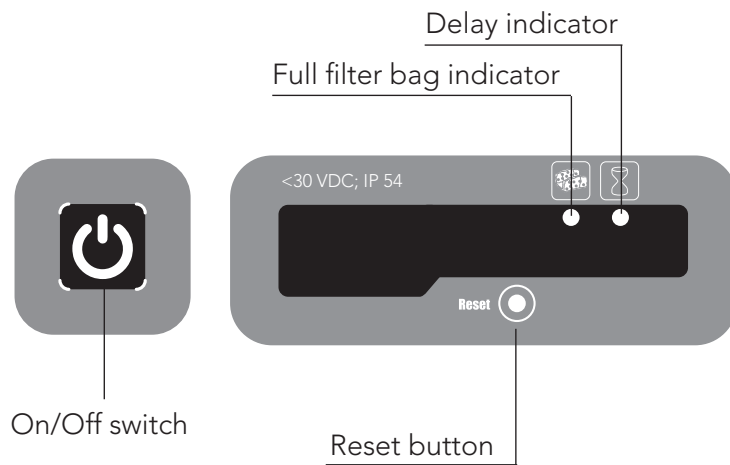
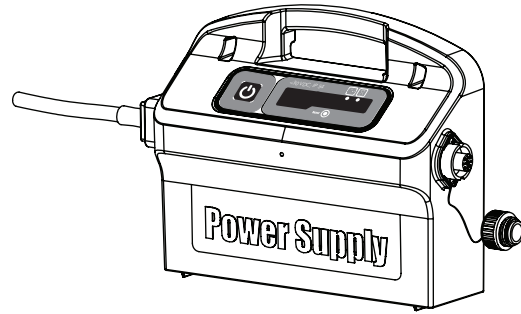

Indicateur de sac filtre plein et touche de réinitialisation (Reset)

Le boîtier d'alimentation est équipé d'un voyant indiquant l'état du sac filtre.

Le voyant DEL rouge donne deux indications différentes selon le cas.

- S'il clignote – le sac filtre est partiellement plein.
- S'il est allumé en continu – le filtre est plein et doit être vidé, puis nettoyé.

Si le voyant ne s'éteint pas après que le sac filtre ait été vidé et nettoyé, appuyez sur la touche RESET pendant que le robot fonctionne.



Indicateur de temporisation (Delay)

Le boîtier d'alimentation est équipé d'un voyant indiquant si l'option de temporisation a été activée ou non (à distance, par télécommande).

7. LA TÉLÉCOMMANDE

La télécommande (RCU – Remote Control Unit) dispose de deux modes de fonctionnement – un mode de contrôle automatique et un mode de contrôle manuel de direction.

En mode automatique, tous les paramètres sont modifiables.

En mode manuel, la direction du robot nettoyeur de piscine peut être contrôlée manuellement.

Panneau de contrôle de la télécommande















Mode de contrôle manuel de la direction

<p>Bouton Marche/ Arrêt</p>	<ol style="list-style-type: none"> 1. Appuyez une fois sur le bouton Marche / Arrêt (ON/OFF) - La télécommande démarre en mode de contrôle manuel de la direction 2. Pour contrôler manuellement la direction du robot nettoyeur, utilisez les touches directionnelles selon le sens des flèches (voir schéma de droite) 	<p>Flèches de contrôle de la direction</p>
-----------------------------	--	--

Sortie du Mode de Contrôle Manuel et Réglage du mode automatique

<p>Sélecteur de mode Manuel/ Automatique</p>	<ol style="list-style-type: none"> 1. Pour quitter le mode de contrôle manuel de la direction, appuyez UNE SEULE fois sur le sélecteur de mode Manuel / Automatique 2. L'afficheur numérique s'allume et trois lignes de boutons fonctionnels s'affichent avec le paramétrage défini par défaut 	
<p>Flèches de contrôle de la direction</p>	<ol style="list-style-type: none"> 1. Modifiez les paramètres à l'aide des flèches orientées vers le haut ou vers le bas. Pour sélectionner les divers réglages, utilisez les flèches orientées vers la droite ou vers la gauche 2. Dès que vous atteignez la fonction voulue, il vous suffit d'appuyer sur le bouton Réglage / Validation (Set/OK) 	<p>Bouton Réglage/ Validation</p>

Appuyez tout d'abord sur la touche Manuel Automatique pour sélectionner le mode, ensuite réalisez les réglages selon le tableau ci-dessous:

 <p>Indicateur de cycle de nettoyage Cette touche détermine la durée du cycle de nettoyage. La télécommande vous permet de choisir parmi les options suivantes.</p>	 <p>Rapide Cycle de 4 h</p>	 <p>Efficace (Réglage par défaut) Cycle de 6 h. pour une utilisation quotidien.</p>	 <p>Extra Cycle de 8 h</p>	
 <p>Indicateur de temporisation Cette touche détermine le moment de déclenchement du cycle par l'appareil. Un début de cycle différé (temporisé) permet de laisser les impuretés se déposer au fond de la piscine.</p>	 <p>Début de cycle immédiat (Réglage par défaut)</p>	 <p>Temporisation d'une heure</p>	 <p>Temporisation de deux heures</p>	
 <p>Indicateur du mode de nettoyage Cette touche vous permet de choisir parmi les options suivantes.</p>	 <p>Standard Nettoyage du sol et des parois. (Réglage par défaut)</p>	 <p>Ultra-propre Aspiration plus puissante et mouvement plus lent. (Sol et parois)</p>	 <p>Sol uniquement Nettoie seulement le sol et les plinthes.</p>	 <p>Parois seulement Nettoie seulement les parois et la bordure de l'eau. (Sauf le modèle Dolphin 2x2 Gyro)</p>

Remarque:

- Au bout de 2 minutes d'inactivité des touches, la télécommande s'éteint et le robot nettoyeur poursuit le cycle entamé selon le paramétrage en cours.
- A la fin des cycles "Ultra-propre" et "Parois seulement", le robot nettoyeur récupère les réglages définis par défaut.

IT

Dolphin 2x2 Gyro pulitore per piscina Istruzioni per l'uso

Contents

1. INTRODUZIONE.....	22
2. SCHEDA TECNICA.....	22
3. AVVERTENZE E PRECAUZIONI	22
3.1. Avvertenze.....	22
3.2. Precauzioni	22
4. PARTI DI RICAMBIO PER PULITORE	23
5. UTILIZZAZIONE DEL PULITORE	24
5.1. Installazione.....	24
5.2. Immergete il pulitore nella piscina.....	25
5.3. Estrazione del pulitore dalla piscina.....	25
5.4. Manutenzione	26
5.5. Manutenzione fuori stagione.....	27
6. ALIMENTAZIONE.....	28
7. TELECOMANDO.....	29

Dolphin 2x2 Gyro pulitore per piscina

Instruzioni per l'uso

1. INTRODUZIONE

Vi ringraziamo per aver acquistato un pulitore per piscina robotico della Maytronics.

Con il pulitore robotico della Maytronics la pulizia della vostra piscina sarà garantita, comoda ed economica. Il filtraggio garantito in tutte le condizioni, lo spazzolamento vigoroso e la capacità delle spazzole di scalare tutti i tipi di superficie massimizzano l'igiene della piscina.

Il pulitore per piscina robotico della Maytronics fornisce una tecnologia di pulizia avanzata, prestazioni di lunga durata e facile manutenzione. Potrete nuotare con la vostra famiglia senza pensieri, certi che la vostra piscina è veramente pulita.

2. SCHEDA TECNICA

Protezione del motore: Codice IP 68

Profondità minima: 0.80 m/2.6 ft

Profondità massima: 5 m/16.4 ft

3. AVVERTENZE E PRECAUZIONI

3.1. Avvertenze



- Usate soltanto l'alimentatore elettrico originariamente fornito
- Assicuratevi che la presa elettrica sia protetta da un interruttore differenziale o da un interruttore termico
- Non tenete l'alimentatore elettrico in acqua
- Ponete l'alimentatore elettrico almeno 3 m/10 ft dall'orlo della piscina
- Non entrate in piscina mentre il pulitore è in funzione
- Staccate l'alimentatore elettrico prima di effettuare la manutenzione

3.2. Precauzioni

Quando non in uso tenete il pulitore all'ombra sul suo Caddy.

Usate il pulitore soltanto quando l'acqua è nelle seguenti condizioni:

Cloro	Máx. 4 ppm
pH	7,0 - 7,8
Temperatura	6 - 34 °C
NaCl	Máximo = 5000 ppm

4. PARTI DI RICAMBIO PER PULITORE

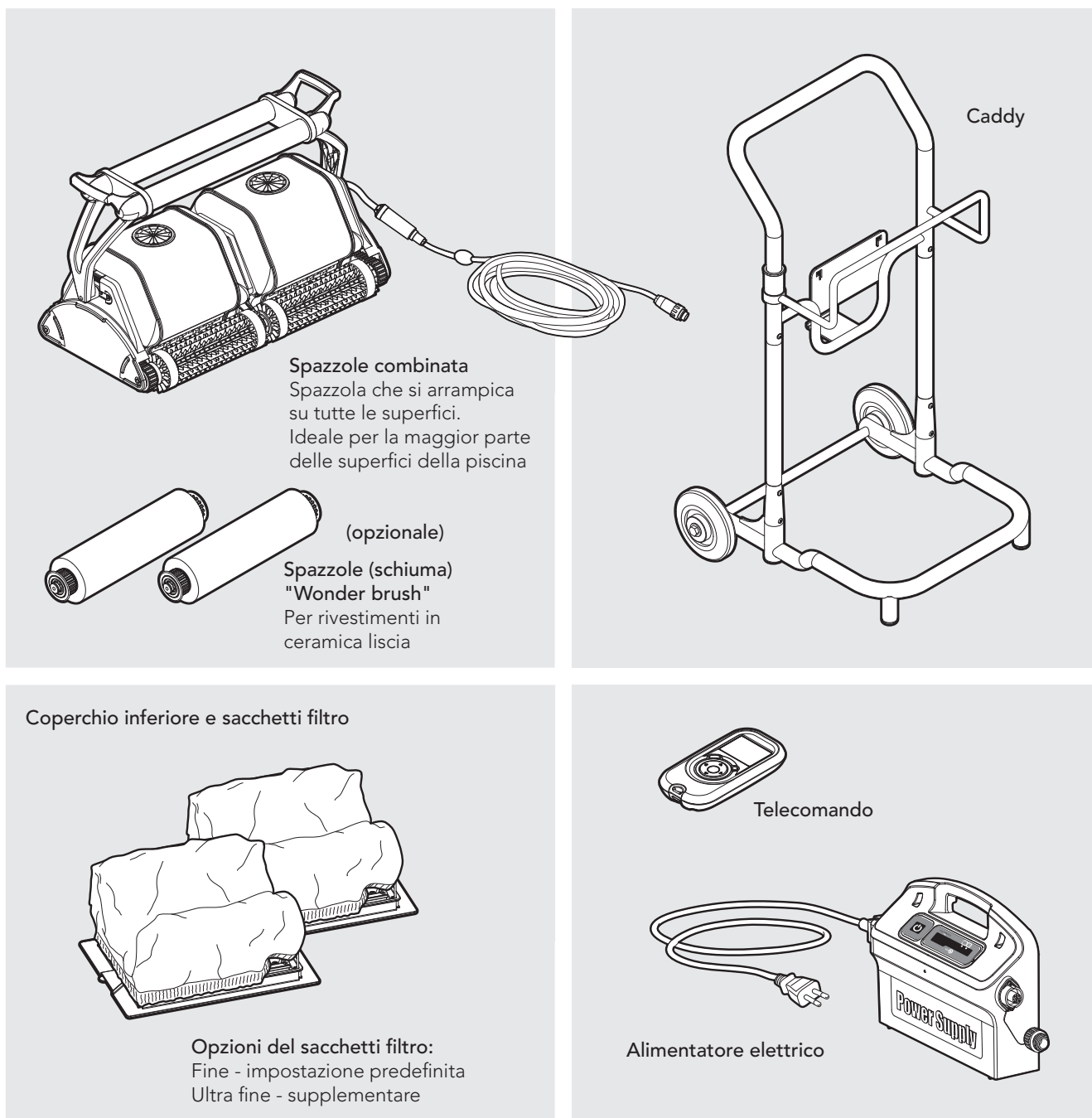

5. UTILIZZAZIONE DEL PULITORE

5.1. Installazione

Collocare il trasformatore approssimativamente al centro del lato più lungo della piscina ad una distanza di 3m/10ft.

Attaccare il cavo galleggiante al trasformatore allineando la tacca del connettore (1) con la scanalatura della presa del trasformatore e avvitare in senso orario (2).

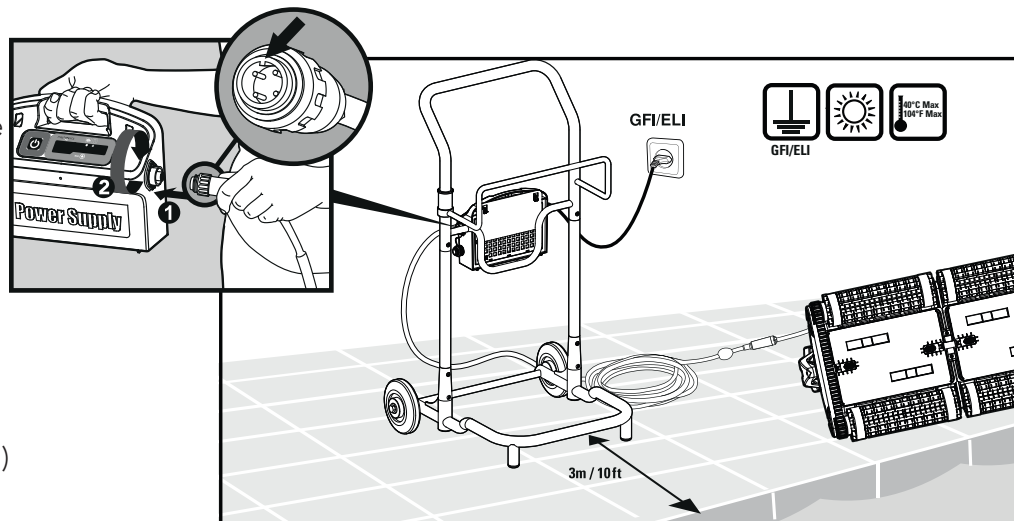

Cambiare la posizione diagonale della maniglia per il movimento di lato alla linea di galleggiamento.

Per regolare l'angolo dell'impugnatura:
A. Premere il fermo in basso e trattenercelo.

B. Spostare l'impugnatura alla posizione desiderata e rilasciare il fermo per trattenerla in posizione.

1 - 2 Avanzamento normale Per un'azione di pulizia più efficiente sulla linea di livello.

3 - 4 Avanzamento veloce

Alta velocità – Per un'azione di pulizia più veloce ma meno efficiente della linea di livello.

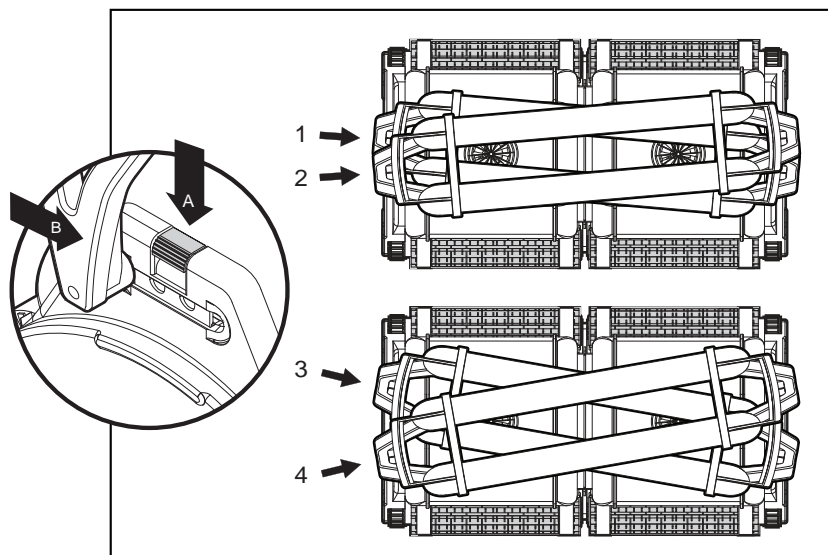

5.2. Immergete il pulitore nella piscina

Se la spazzola Wonder/anelli Wonder sono asciutti immergeteli in acqua fino a farli ammorbidire.

Scuotere il robot di da un lato all'altro o girarlo a testa in giù per liberarne l'aria imprigionata. Lasciate che si posi sul fondo della piscina.

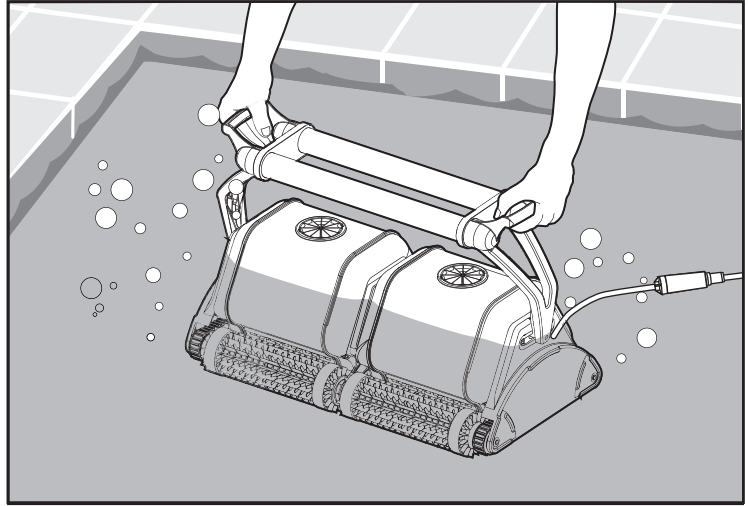

Inserite il trasformatore.

Il pulitore ora si metterà in funzione ed eseguirà il suo programma di pulizia fino alla fine.

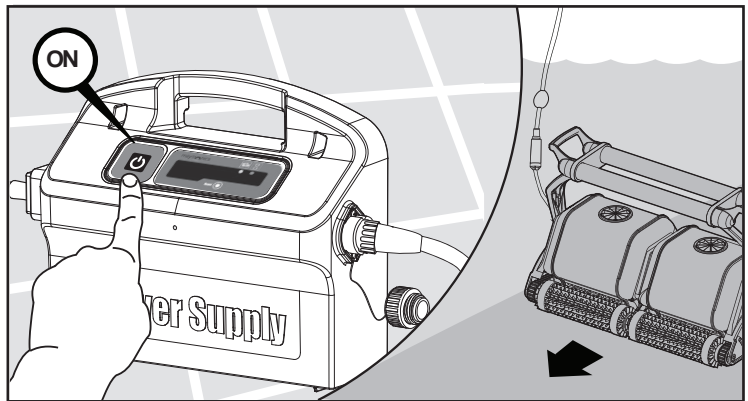

5.3. Estrazione del pulitore dalla piscina

Il robot si disattiverà automaticamente alla fine del ciclo di pulizia.

 Spegnete e staccate il trasformatore.

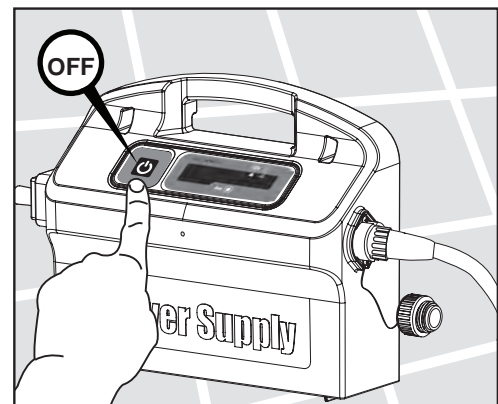

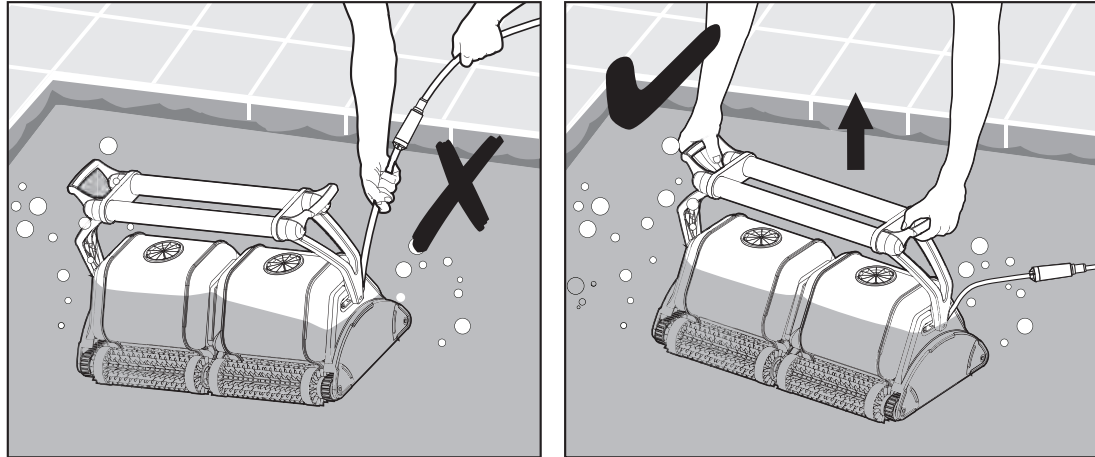

Usando il cavo galleggiante, tirare il pulitore verso il bordo della piscina.

Usando l'impugnatura, tirare il pulitore fuori dalla piscina.

! NON ESTRAETE IL PULITORE DALLA PISCINA TIRANDO IL CAVO.

5.4. Manutenzione

Sciacquate i sacchetti filtro sotto l'acqua corrente. Periodicamente pulite le spazzole sotto l'acqua corrente.

È raccomandabile lavare periodicamente i sacchetti-filtro in una macchina lavatrice. Selezionare un programma di lavaggio per materiali sintetici.

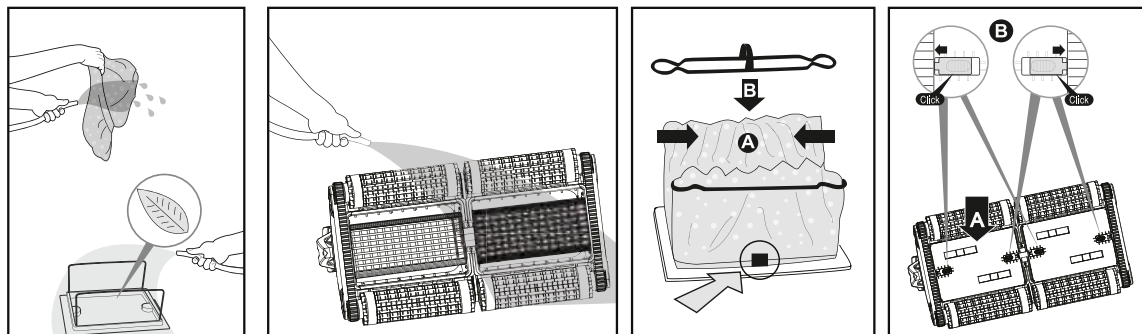
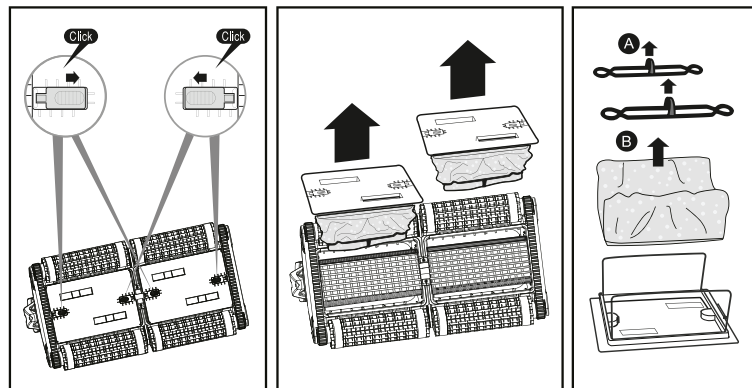

Pulizia della girante

 **Staccate il trasformatore.**

Se la girante è ostruita da detriti, aprirla e rimuoverli.

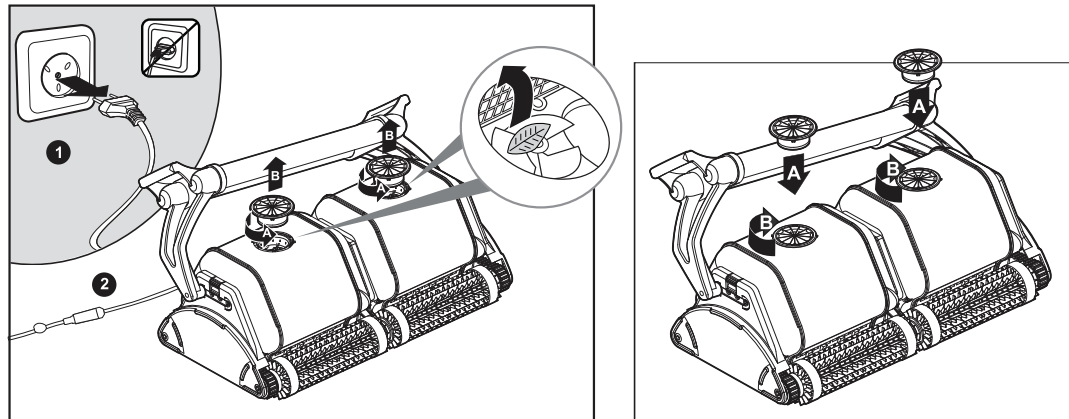

Cavo

Per eliminare l'attorcigliamento, stendere tutto il cavo e lasciarlo al sole per almeno una giornata.

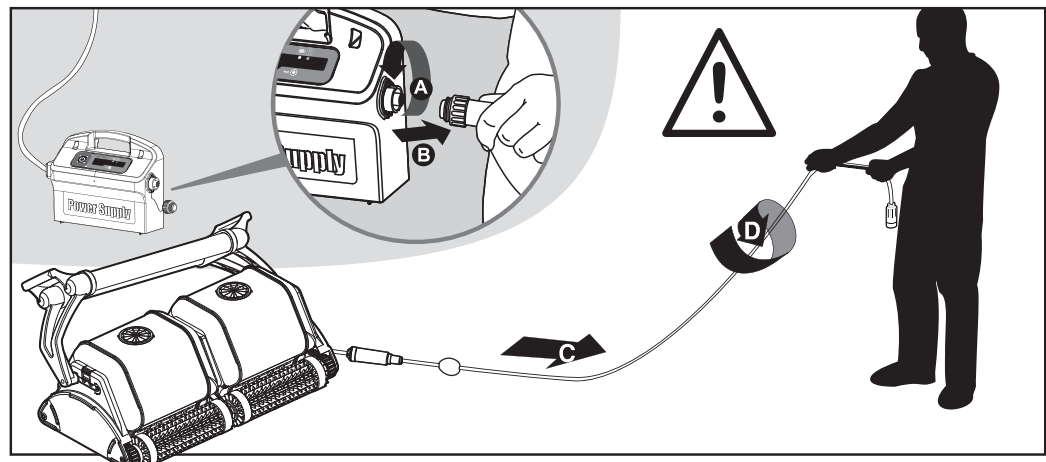

5.5. Manutenzione fuori stagione

Se il pulitore non verrà utilizzato per un lungo periodo, prima di metterlo via, eseguite le operazioni seguenti:

- Assicuratevi che non vi sia più acqua all'interno del pulitore
- Pulite accuratamente e rimettete a posto il sacchetti filtro
- Arrotolate il cavo in modo che non sia attorcigliato e mettetelo nel Caddy
- Mettete il pulitore al riparo o sul suo Caddy o semplicemente capovolto

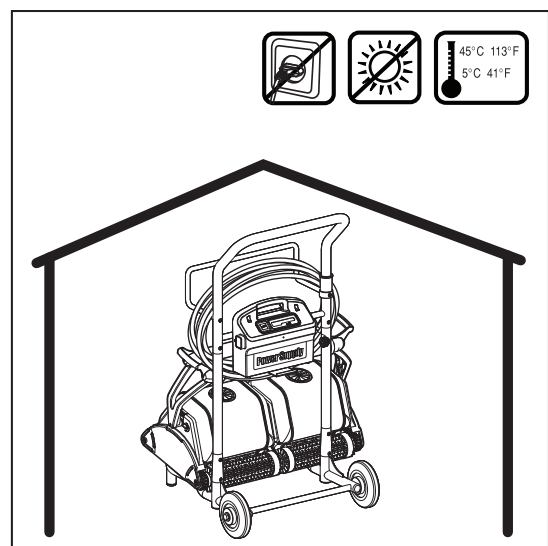

6. ALIMENTAZIONE

Alimentatore digitale "Switch-Mode" con indicatore di sacco del filtro pieno e di ritardo.

- Ingresso - 100-250 AC Volts
- 50-60 Hertz
- 220 Watt
- Uscita - <30 VDC
- IP 54

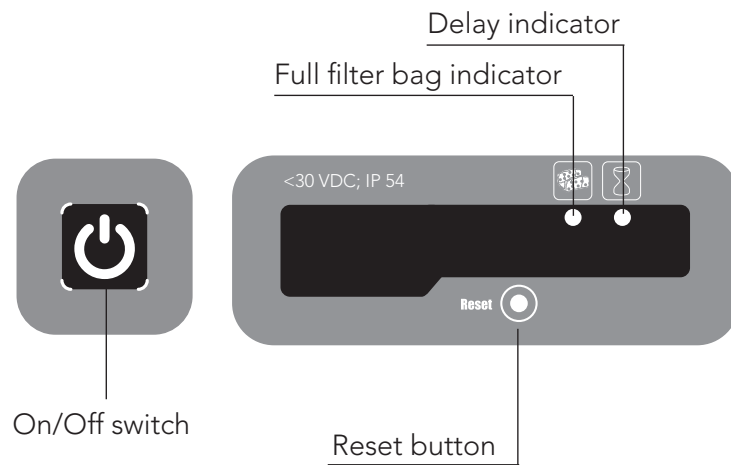
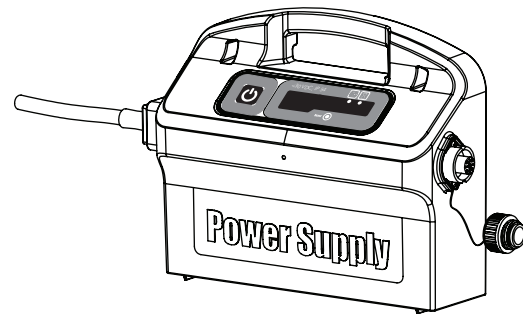

Indicatore di filtro pieno e tasto Reset

L'alimentatore è equipaggiato di indicatore di stato del sacchetto filtro.

Il LED rosso indica due situazioni del filtro.

- Lampeggiante – il sacchetto filtro è parzialmente bloccato.
- Acceso – il filtro è bloccato e deve essere vuotato e pulito.

Se il LED non si spegne dopo che il sacchetto filtro è stato vuotato e pulito, premere il tasto RESET, mentre il robot è operante.



Indicatore di ritardo (Delay)

L'alimentatore è equipaggiato con un indicatore di Ritardo che indica se l'opzione di ritardo è attivata (tramite il telecomando).

7. TELECOMANDO

Il pannello di controllo del telecomando

Il telecomando offre due modalità operative – la modalità automatica e la modalità di controllo manuale della direzione.

In modalità automatica, tutti i parametri relativi alla pulizia possono essere modificati.

In modalità direzione manuale, la direzione del robot di pulizia della piscina può essere controllata manualmente.

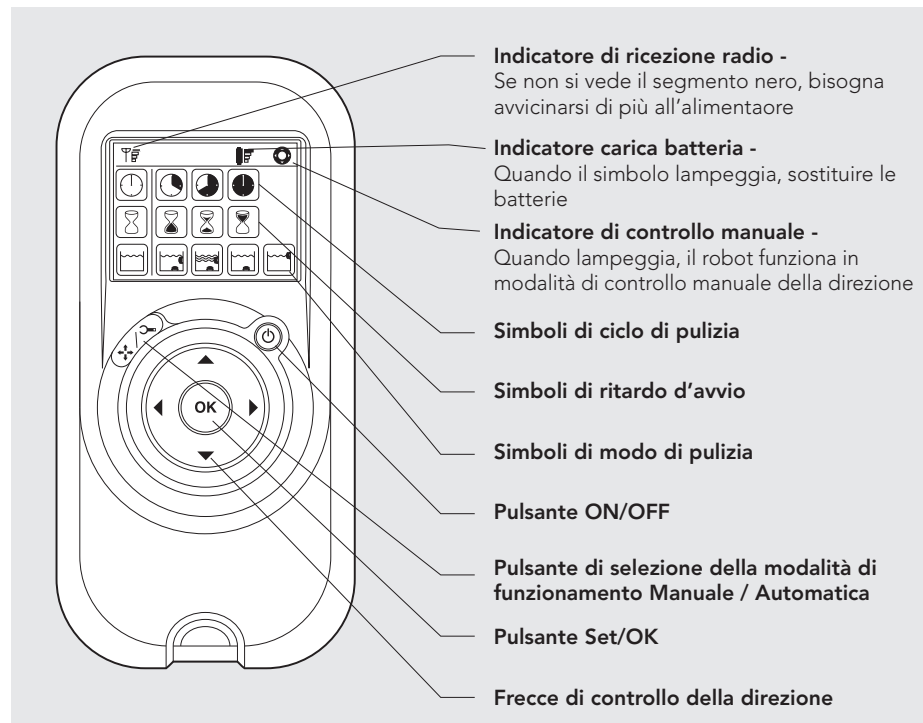













Modalità di controllo manuale della direzione

<p>Pulsante On/Off</p>	<ol style="list-style-type: none"> 1. Premere una volta il pulsante ON/OFF - Il telecomando avvia il robot in modalità di controllo manuale della direzione 2. Per controllare manualmente la direzione del robot, utilizzare le frecce di controllo della direzione (come illustrato nella figura a destra) 	<p>Frecce per il controllo della direzione</p>
------------------------	--	--

Impostazione della modalità automatica di funzionamento al posto della modalità di controllo manuale della direzione

<p>Pulsante di selezione della modalità Manuale /Automatica</p>	<ol style="list-style-type: none"> 1. Per uscire dalla modalità di controllo manuale della direzione, premere UNA SOLA VOLTA il pulsante di selezione della modalità Manuale / Automatica 2. Il quadrante digitale si illumina ed appaiono tre file di simboli in modalità predefinita 	
<p>Frecce di controllo della direzione</p>	<ol style="list-style-type: none"> 1. Per modificare i parametri premere le frecce in su o in giù. Per scegliere le impostazioni dei parametri usare le frecce a destra ed a sinistra. 2. Una volta raggiunta la funzione desiderata, premere il pulsante Set/OK 	<p>Pulsante Set/OK</p>

Premere prima il pulsante di selezione della modalità Manuale / Automatica, poi eseguire le impostazioni secondo la tabella che segue:

 <p>Indicatore del ciclo di pulizia Questo determina la durata del ciclo di pulizia. Il telecomando consente di scegliere tra le opzioni seguenti.</p>	 <p>Veloce Ciclo della durata di 4 ore</p>	 <p>Efficiente (Impostazione predefinita) Ciclo della durata di 6 ore per uso quotidiano</p>	 <p>Extra Ciclo della durata di 8 ore</p>	
 <p>Indicatore del tempo in cui l'avvio è posticipato Questo stabilisce quando il robot per la pulizia della piscina viene attivato. L'avvio posticipato consente allo sporco di depositarsi sul fondo della piscina.</p>	 <p>Avvio immediato (Impostazione predefinita)</p>	 <p>Un'ora di ritardo</p>	 <p>Due ore di ritardo</p>	
 <p>Indicatore del modo di pulizia Consente di scegliere tra i seguenti modi di pulizia.</p>	 <p>Standard Pulizia di fondale e pareti (Impostazione predefinita)</p>	 <p>Ultra-pulito Maggiore suzione e movimento più lento. (fondale e pareti)</p>	 <p>Solo fondale Pulizia di soli fondale ed angoli</p>	 <p>Solo pareti Pulizia di sole pareti e linea di livello dell'acqua. (Eccetto il modello Dolphin 2x2 Gyro)</p>

Nota:

- Dopo 2 minuti, se non viene premuto alcun pulsante, il telecomando si spegne ed il robot continua a funzionare in base alle impostazioni selezionate in precedenza.
- Quando termina il ciclo nei modi di pulizia "Ultra-pulito" e "Solo pareti", il robot ritorna alle impostazioni predefinite.

ES

Dolphin 2x2 Gyro robot limpiador de piscinas

Instrucciones de uso

Índice

1. INTRODUCCIÓN.....	32
2. ESPECIFICACIONES	32
3. ADVERTENCIAS Y PRECAUCIONES.....	32
3.1. Advertencias.....	32
3.2. Precauciones	32
4. PIEZAS DEL LIMPIADOR DE PISCINAS	33
5. USO DEL LIMPIADOR DE PISCINAS.....	34
5.1. Preparación	34
5.2. Inmersión del limpiador en la piscina.....	35
5.3. Extracción del limpiador de la piscina.....	35
5.4. Mantenimiento.....	36
5.5. Almacenamiento fuera de temporada.....	37
6. FUENTE DE ALIMENTACIÓN	38
7. LA UNIDAD DE CONTROL REMOTO (RCU).....	39

Dolphin 2x2 Gyro robot limpiador de piscinas

Instrucciones de uso

1. INTRODUCCIÓN

Gracias por comprar el robot limpiador de piscinas de Maytronics.

Estamos seguros de que con el robot limpiador de piscinas de Maytronics, usted podrá limpiar su piscina de una forma cómoda, segura y rentable. La fiabilidad del filtrado, independientemente del estado de la piscina, el cepillado activo y la habilidad para trepar en todo tipo de superficies aumentan al máximo la higiene de la piscina.

Los robots limpiadores de piscinas de Maytronics emplean avanzadas tecnologías de limpieza, tienen un rendimiento duradero y su mantenimiento es sencillo. Usted y su familia podrán disfrutar de un baño con total confianza de que su piscina está completamente limpia.

2. ESPECIFICACIONES

Protección del motor: IP 68

Profundidad mínima: 0,80 m/2,60 ft

Profundidad máxima: 5,00 m/16,4 ft

3. ADVERTENCIAS Y PRECAUCIONES



3.1. Advertencias

- Use únicamente la fuente de alimentación original suministrada
- Asegúrese de que la toma de corriente está protegida por un interruptor diferencial o por un interruptor de fuga a tierra
- Mantenga la fuente de alimentación alejada del agua
- Coloque la fuente de alimentación a una distancia de al menos 3 m desde el borde de la piscina
- No entre a la piscina mientras el limpiador de piscina esté en funcionamiento
- Desenchufe la fuente de alimentación antes de realizar el mantenimiento

3.2. Precauciones

Cuando no use el limpiador de piscinas, colóquelo en el Carro, en un lugar a la sombra.

Use el limpiador de piscinas únicamente bajo las siguientes condiciones del agua:

Cloro	Máx. 4 ppm
pH	7,0 - 7,8
Temperatura	6 - 34 °C (43 -93°F)
NaCl	Máximo = 5000 ppm

4. PIEZAS DEL LIMPIADOR DE PISCINAS

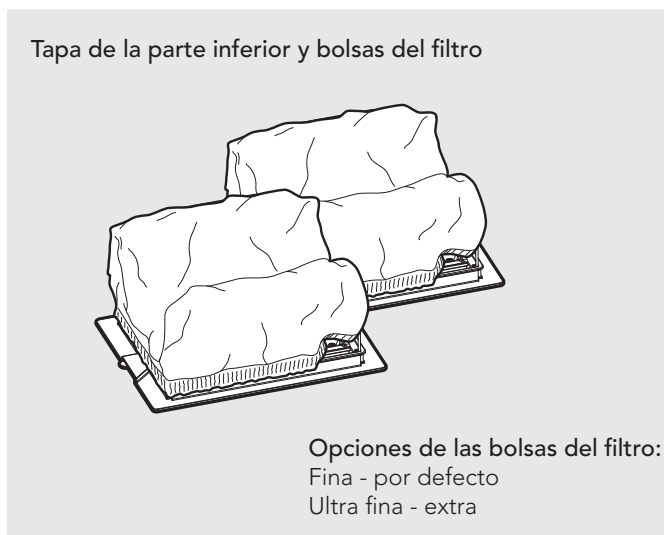
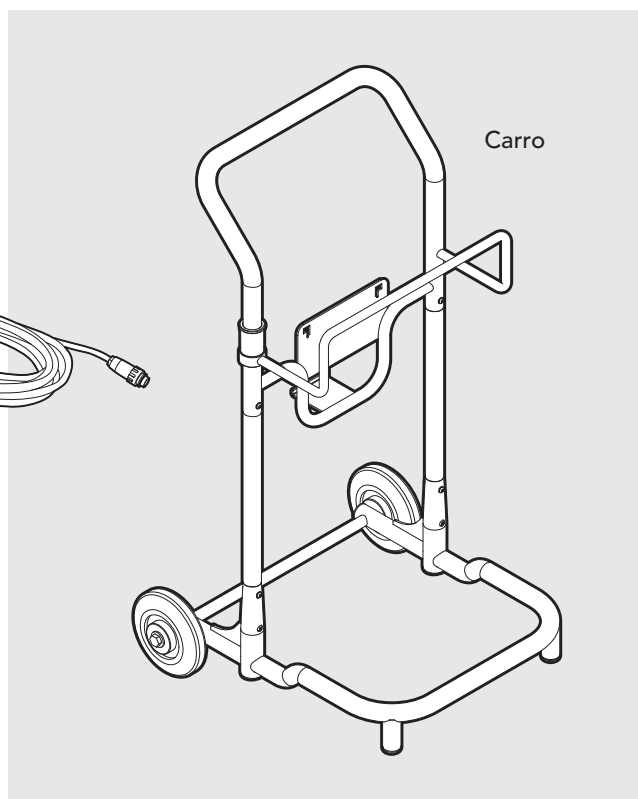
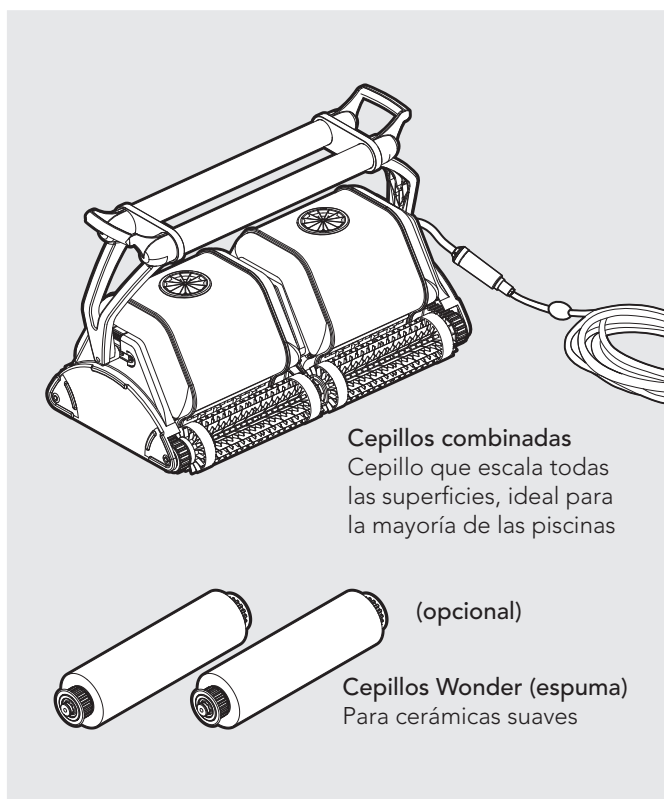

5. USO DEL LIMPIADOR DE PISCINAS

5.1. Preparación

Coloque la fuente de alimentación de modo que esta quede aproximadamente en el medio del lado de mayor longitud de la piscina, a una distancia de 3 m del borde.

Acople el cable flotador a la fuente de alimentación introduciéndolo de forma que el saliente del conector (1) quede alineado con la muesca del enchufe de la fuente de alimentación y, a continuación, gire en sentido horario (2).

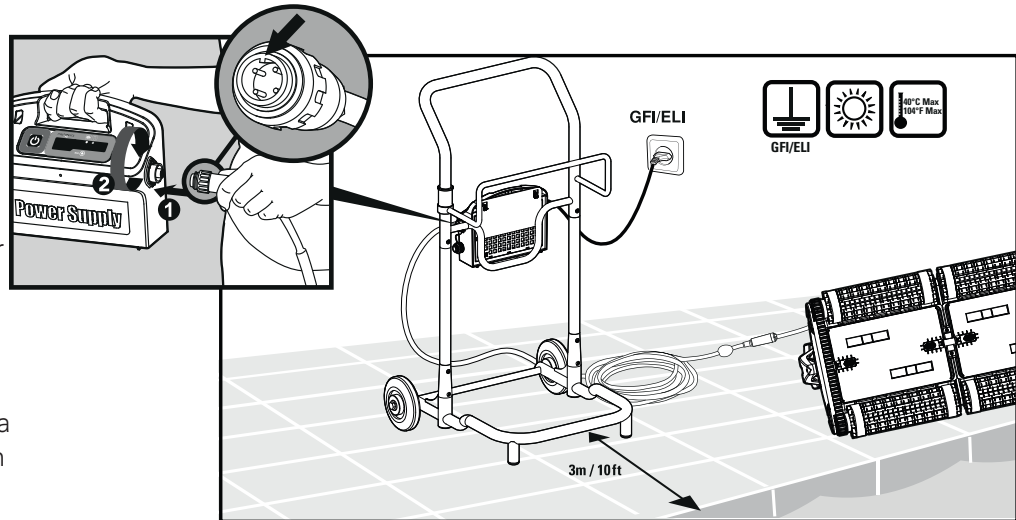

Cambie la posición diagonal de la manija para movimiento lateral de la línea de fluctuación.

Para ajustar el ángulo del mango:

A. Presione el pestillo hacia abajo y manténgalo en esa posición.

B. Mueva la palanca a la posición deseada y suelte el pestillo para sujetar el mango en su lugar.

1 - 2 Avanzo Normal

Acción de limpieza más eficiente en la línea de flotación.

3 - 4 Avanzo Rápido

Velocidad rápida – Para limpieza más rápida pero menos eficiente en la línea de flotación.

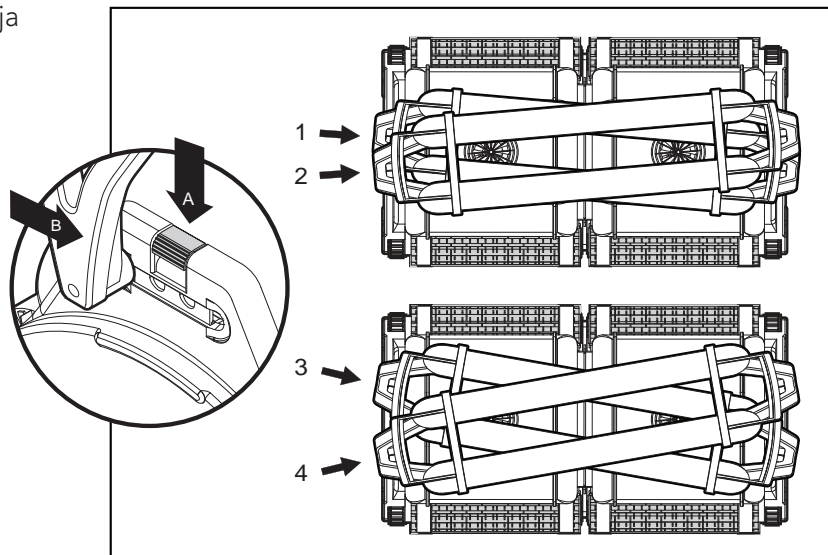

5.2. Inmersión del limpiador en la piscina

Si el cepillo Wonder/los anillos Wonder están secos, sumérgalos en agua hasta que estén suaves.

Sacuda el robot de lado a lado o póngalo boca arriba para soltar el aire retenido.

Deje que se hunda hasta el fondo de la piscina.

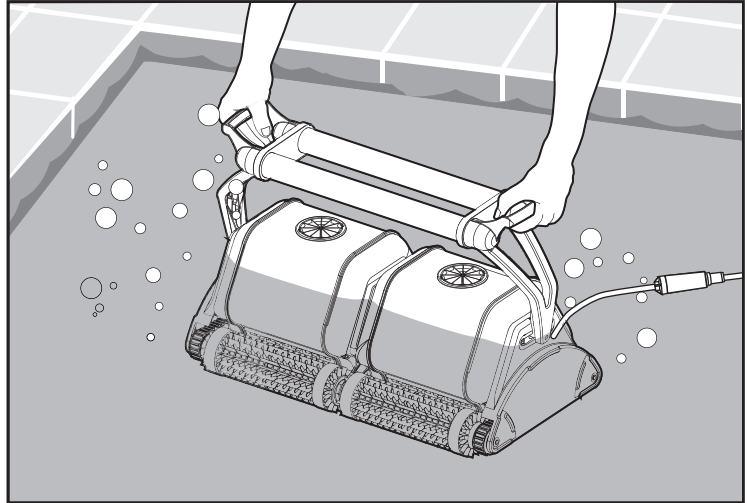

Encienda la fuente de alimentación.

El limpiador de piscinas estará en funcionamiento hasta que termine el ciclo de limpieza.

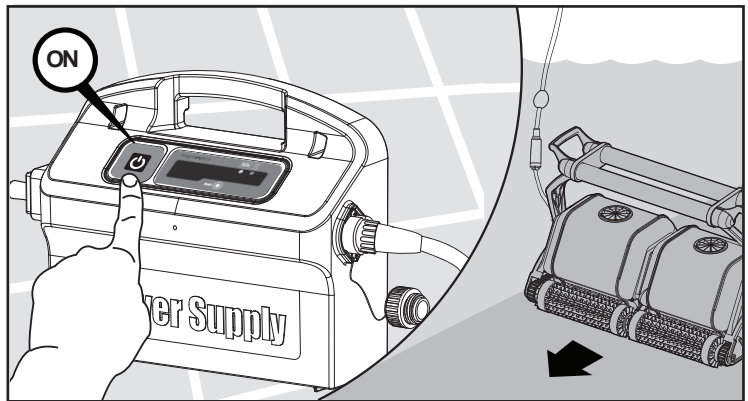

5.3. Extracción del limpiador de la piscina

El robot efectuará el apagado automático al término del ciclo de limpieza.

 Apague y desenchufe la fuente de alimentación.

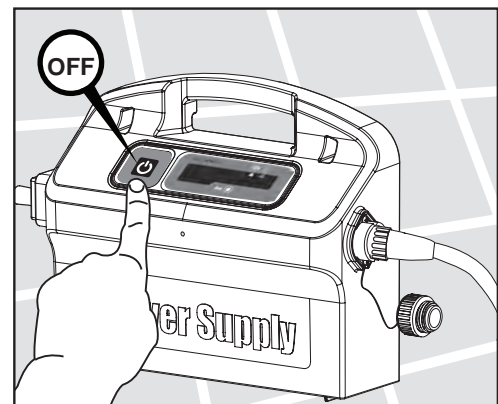

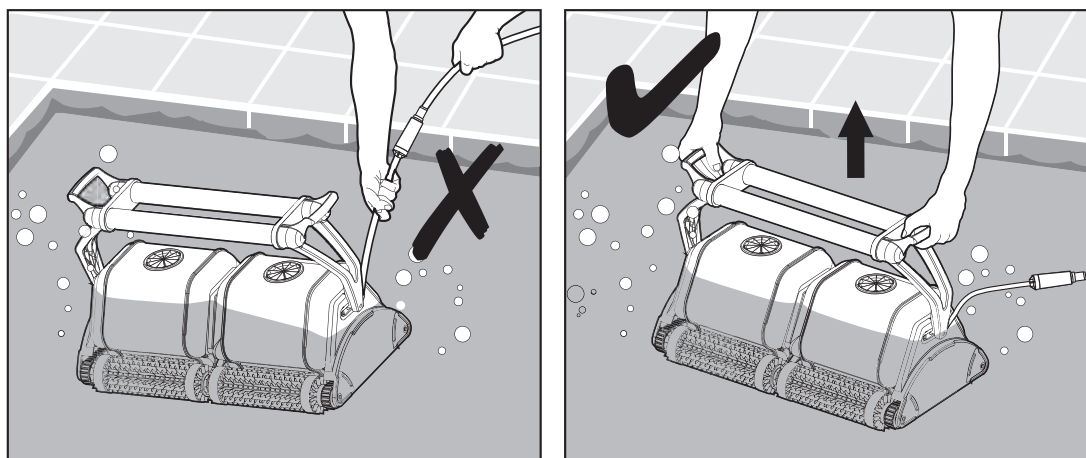

Use el cable flotador para acercar el limpiador hasta el borde de la piscina.
 Use el asa para sacar el limpiador de la piscina.

 NO USE EL CABLE PARA SACAR EL LIMPIADOR DE LA PISCINA.

5.4. Mantenimiento

Limpié las bolsas del filtro con una manguera. Limpié los cepillos periódicamente con una manguera. Se recomienda lavar periódicamente las bolsas del filtro en una máquina lavadora. Utilice el programa para el lavado suave.

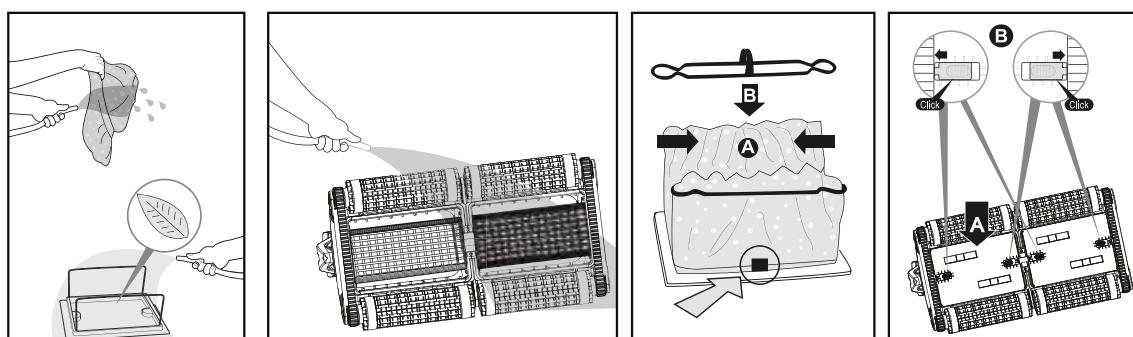
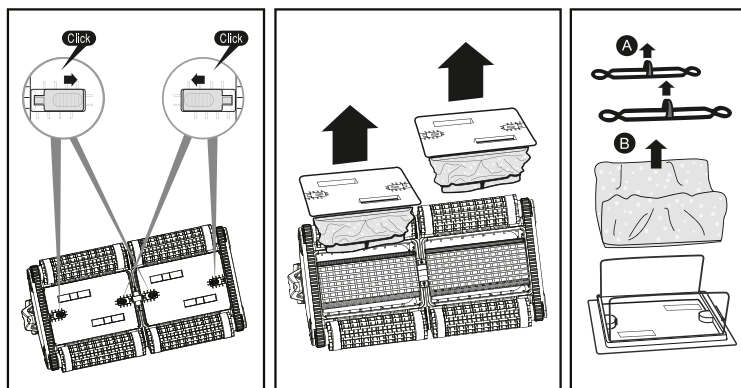

Limpeza de la turbina

 **Desenchufe la fuente de alimentación.**

Si nota que hay suciedad atrapada en la turbina, abra la cubierta y extraiga la suciedad.

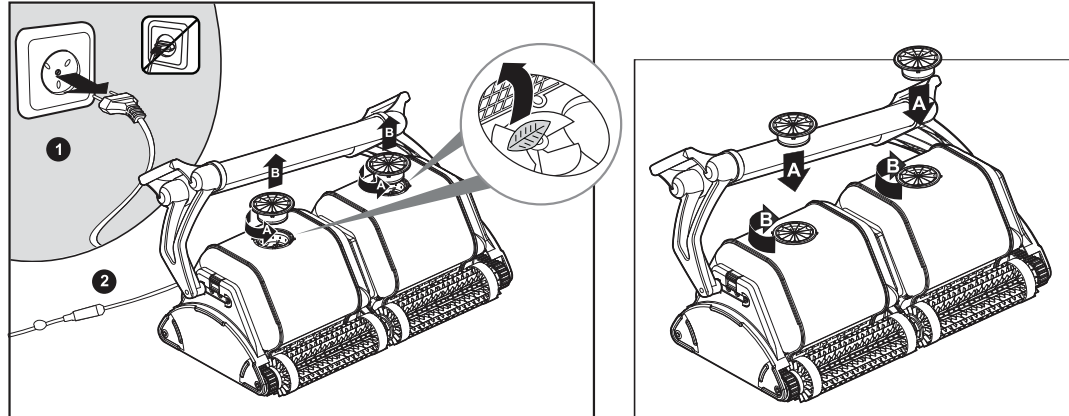

Cable

Para eliminar las torceduras, estire completamente el cable y déjelo reposar al sol durante al menos un día.

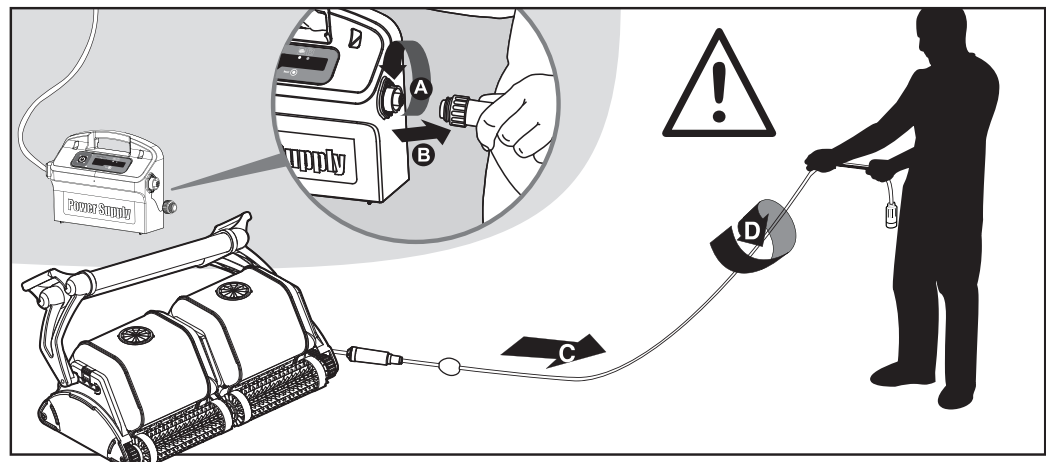

5.5. Almacenamiento fuera de temporada

Si no va a usar el limpiador de piscinas durante un período prolongado, siga los pasos de almacenamiento que se indican a continuación:

- Asegúrese de que no hay agua en el limpiador de piscinas
- Limpie a fondo las bolsas del filtro e introdúzcala en su sitio
- Enrolle el cable de modo que no tenga torceduras y colóquelo en el Carro
- Almacene el limpiador de piscinas en un lugar protegido, bien en su Carro, o simplemente boca abajo

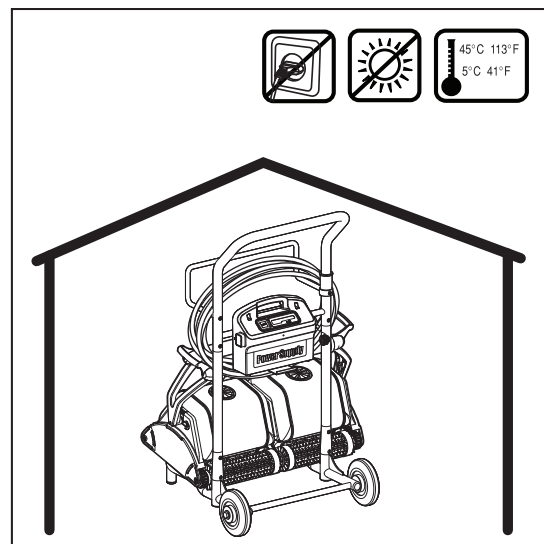

6. FUENTE DE ALIMENTACIÓN

Fuente de Alimentación con Modo de Cambio Digital, con bolsa de filtro llena y indicador de retraso.

- Entrada - 100-250 AC Volts
- 50-60 Hertz
- 220 Watt
- Salida - <30 VDC
- IP 54

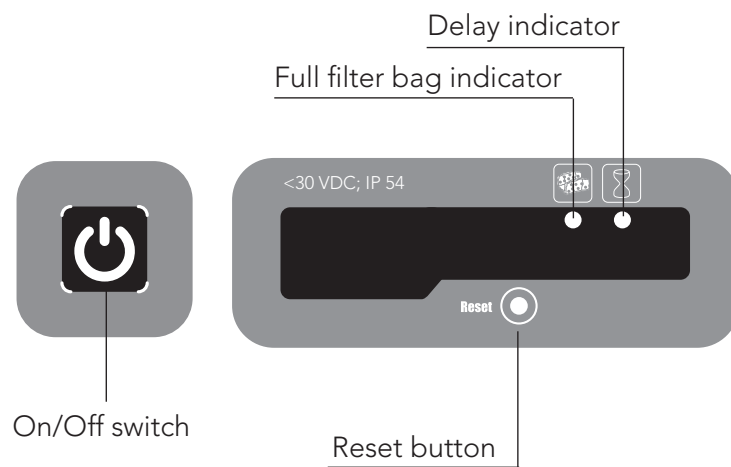
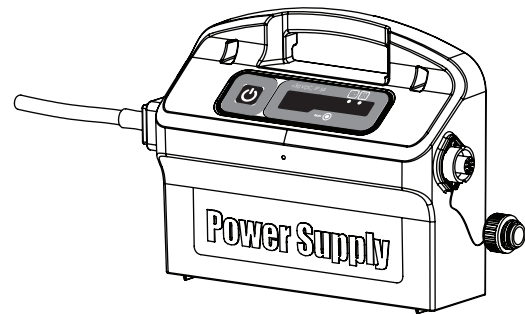

Indicador de bolsa de filtro llena y botón Reset

La fuente de alimentación está equipada con un indicador del estado de la bolsa de filtro.

El LED rojo indica dos condiciones de filtro.

- Cuando parpadea – la bolsa de filtro está parcialmente bloqueada.
- Cuando está iluminado – el filtro está bloqueado y debe ser vaciado y limpiado.

Si el LED no se apaga después de que la bolsa del filtro ha sido vaciada y limpiada, pulse el botón Reset mientras el robot esté trabajando.



Indicador de retardo (Delay)

La fuente de alimentación está equipada con un indicador de retardo que indica si la opción de retardo está activada (a través de la unidad de control remoto).

7. LA UNIDAD DE CONTROL REMOTO (RCU)

La RCU ofrece dos modos de operación – Modo Automático y Modo Manual de Control de dirección.

En el modo Automático, todos los parámetros de limpieza pueden ser modificados.

En el modo Manual de dirección, la dirección del Limpiador de Piscinas puede ser controlada manualmente.

El Panel de Control de la Unidad de Control Remoto

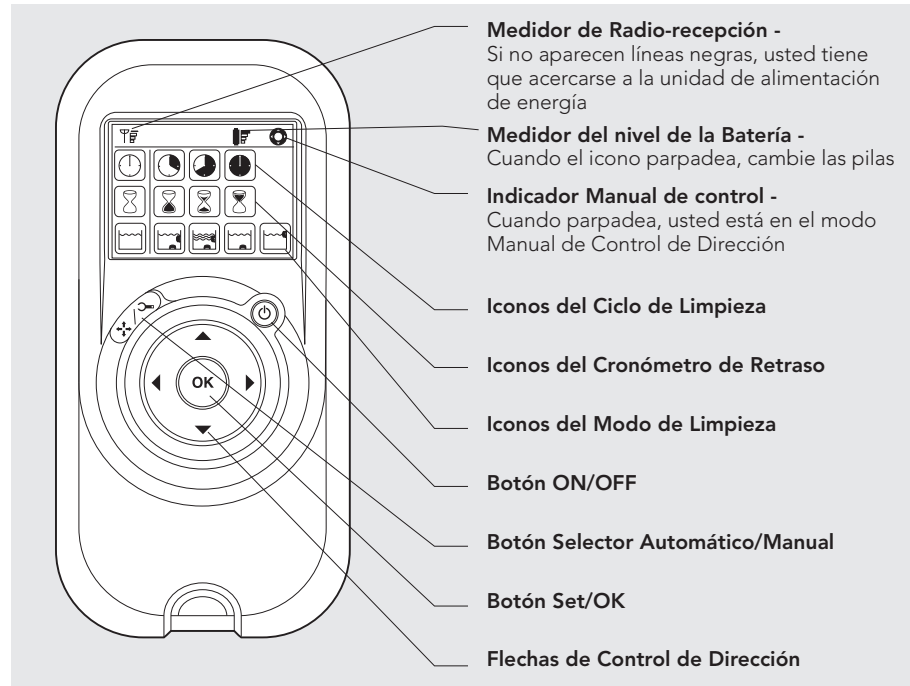

Modo Manual de Control de Dirección

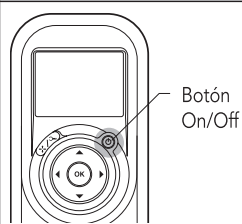

1. Presione el botón ON/OFF una vez -La RCU iniciará en el modo Manual de Control de Dirección
2. Para controlar manualmente la dirección del limpiador, use las flechas de control de dirección (ver a la derecha)

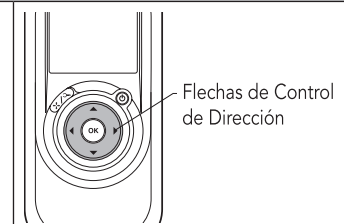

Salir del Modo Manual de Control de Dirección y configurar el Modo Automático

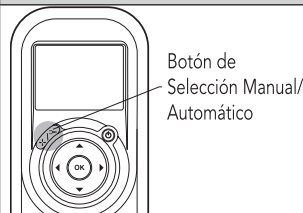



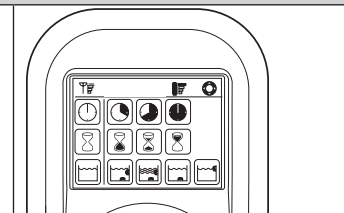



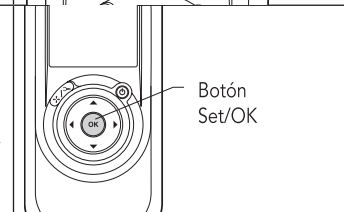





1. Para salir del modo Manual de Control de Dirección, presione el botón de Selección Manual/Automático apenas UNA VEZ
2. La pantalla digital se iluminará y tres líneas de iconos de función aparecerán en el modo predeterminado



1. Para modificar los parámetros presione las flechas para arriba y para abajo. Para elegir la configuración de los parámetros, use las flechas de la derecha o de la izquierda
2. Cuando llegar a la función deseada, presione el botón Set/OK



Primero presione el botón de selección Manual/Automático, después configure según la tabla siguiente:

 <p>Indicador del Ciclo de Limpieza Determina el tiempo del ciclo de limpieza. La RCU permite que usted elija entre las siguientes opciones.</p>	 <p>Rápido Ciclo de 4 horas</p>	 <p>Eficiente (Configuración predeterminada) Ciclo de 6 horas para uso diario</p>	 <p>Extra Ciclo de 8 horas</p>	
 <p>Indicador del Tiempo de Retraso Determina cuando el limpiador de piscina empieza a operar. Un retraso permite que la suciedad se establezca en el fondo de la piscina.</p>	 <p>Inicio Inmediato (Configuración predeterminada)</p>	 <p>Retraso de Una Hora</p>	 <p>Retraso de Dos Horas</p>	
 <p>Indicador de la Acción de Limpieza Permite que usted elija entre las siguientes opciones.</p>	 <p>Standard Limpieza de piso y pared. (Configuración predeterminada)</p>	 <p>Ultra-limpio Más succión y movimiento más lento. (piso y pared)</p>	 <p>Solamente el Piso Limpia solamente el piso y los rincones</p>	 <p>Solamente las Paredes Limpia solamente las paredes y la línea de agua (Excepto el modelo Dolphin 2x2 Gyro)</p>

Nota:

- Pasados 2 minutos, si ninguno de los botones fue presionado, la Unidad de Control Remoto se cierra y el Limpiador de Piscina continuará operando en la configuración anterior.
- Cuando las opciones "Ultra-Limpio" y "Solamente Paredes" concluyen sus ciclos, la Limpiador de Piscina retornará a la configuración preestablecida.

DE

Dolphin 2x2 Gyro Robotic Pool Reiniger

Bedienungsanleitung

Inhalt

1. EINFÜHRUNG.....	42
2. TECHNISCHE BESCHREIBUNG.....	42
3. WARNUNGEN UND SICHERHEITSHINWEISE.....	42
3.1. Warnungen.....	42
3.2. Sicherheitshinweise	42
4. POOLREINIGER-TEILE.....	43
5. VERWENDUNG DES POOLREINIGERS.....	44
5.1. Einstellung.....	44
5.2. Einsetzen des Poolreinigers in den Pool.....	45
5.3. Entnahme des Poolreinigers aus dem Pool.....	45
5.4. Wartung.....	46
5.5. Lagerung außerhalb der saison.....	47
6. STROMVERSORGUNG	48
7. FERNBEDIENUNGSEINHEIT.....	49

Dolphin 2x2 Gyro Pool Reiniger

Bedienungsanleitung

1. EINFÜHRUNG

Vielen Dank, dass Sie einen Maytronics Roboter-Poolreiniger erworben haben.

Wir sind sicher, dass Ihr Maytronics Roboter-Poolreiniger für verlässliche, bequeme und kostengünstige Poolreinigung sorgen wird. Seine verlässliche Filterung unter allen Poolbedingungen, das aktive Abbürsten und die die gesamte Fläche erreichende Bürste erhöhen maximal die Pool-Hygiene.

Der Roboter-Poolreiniger von Maytronics bietet hochentwickelte Reinigungstechnologie, dauerhafte Leistung und einfache Wartung. Sie und Ihre Familie können das Bad in der Gewissheit eines vollkommen sauberen Pools genießen.

2. TECHNISCHE BESCHREIBUNG

Motorschutz: IP 68

Mindesttiefe: 0.80m/2.6ft

Höchsttiefe: 5m/16.4ft

3. WARNUNGEN UND SICHERHEITSHINWEISE

3.1. Warnungen



- Nur das Original-Stromversorgungsgerät verwenden
- Stellen Sie sicher, dass die Steckdose durch einen FI-Schutzschalter (GFI) oder einen Fehlerstromschutzschalter (ELI) geschützt ist
- Halten Sie das Stromversorgungsgerät von stehendem Wasser fern
- Positionieren Sie das Stromversorgungsgerät mindestens 3m/10ft vom Poolrand entfernt
- Gehen Sie nicht in den Pool, solange der Poolreiniger arbeitet
- Stecken Sie das Stromversorgungsgerät aus, bevor Sie Wartungsarbeiten durchführen

3.2. Sicherheitshinweise

Wenn Sie den Poolreiniger nicht verwenden, lagern Sie ihn auf dem Caddy an einem schattigen Platz. Verwenden Sie den Poolreiniger nur bei folgenden Wasserbedingungen:

Chlor	Maximal 4 ppm
pH	7,0 - 7,8
Temperatur	6 – 34°C (43-93°F)
NaCl	Maximum = 5000 ppm

4. POOLREINIGER-TEILE

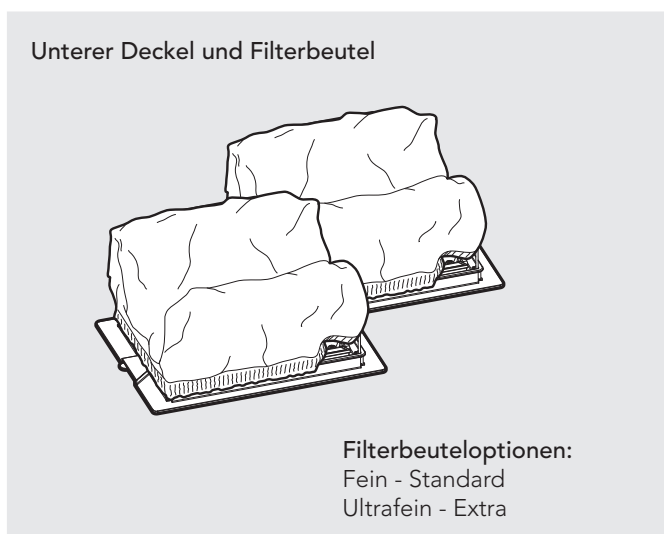
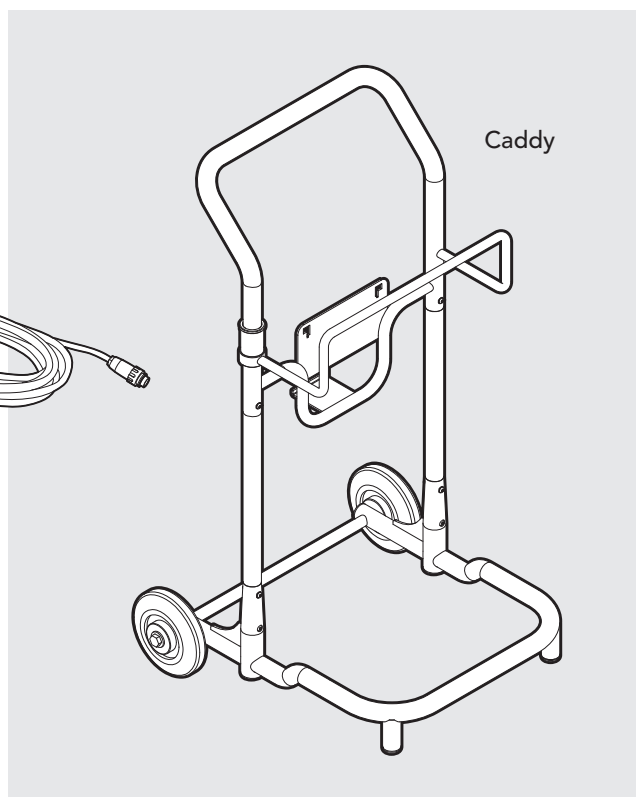
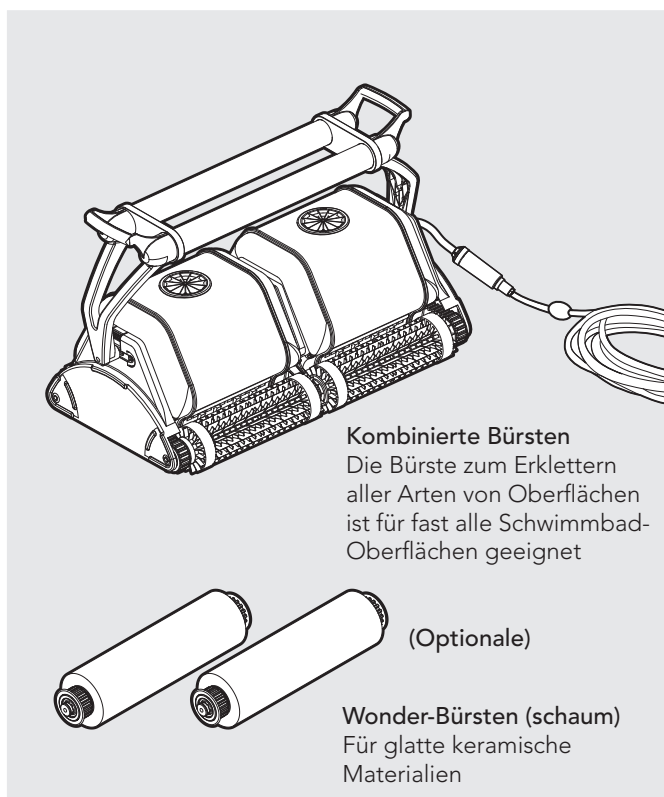

5. VERWENDUNG DES POOLREINIGERS

5.1. Einstellung

Positionieren Sie das Stromversorgungsgerät so, dass es sich in einem Abstand von 3m/10ft ungefähr in der Mitte der Pool-Längsseite befindet.

Verbinden Sie das Schwimmkabel mit dem Stromversorgungsgerät, indem Sie die Nut am Anschluss (1) ausrichten und den Stecker in das Stromversorgungsgerät stecken und dann im Uhrzeigersinn drehen (2).

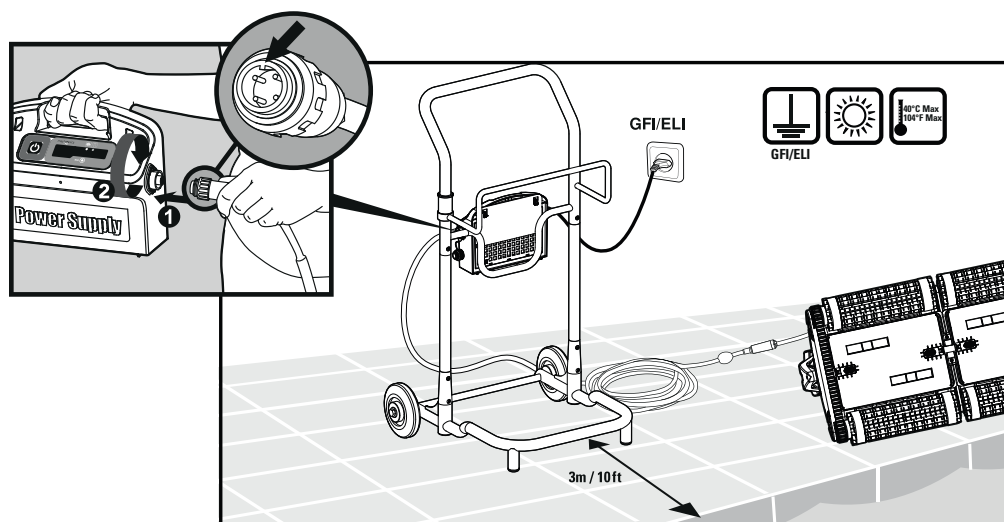

Ändern Sie die Position der Griffs für die Seitwärtsbewegung des Roboters entlang der Wasserlinie.

Um den Griffwinkel einzustellen:

A. Drücken Sie den Riegel nach unten und halten Sie ihn in dieser Position.

B. Bewegen Sie den Griff in die gewünschte Position, und lassen Sie den Riegel los um den Griff in dieser Position zu halten.

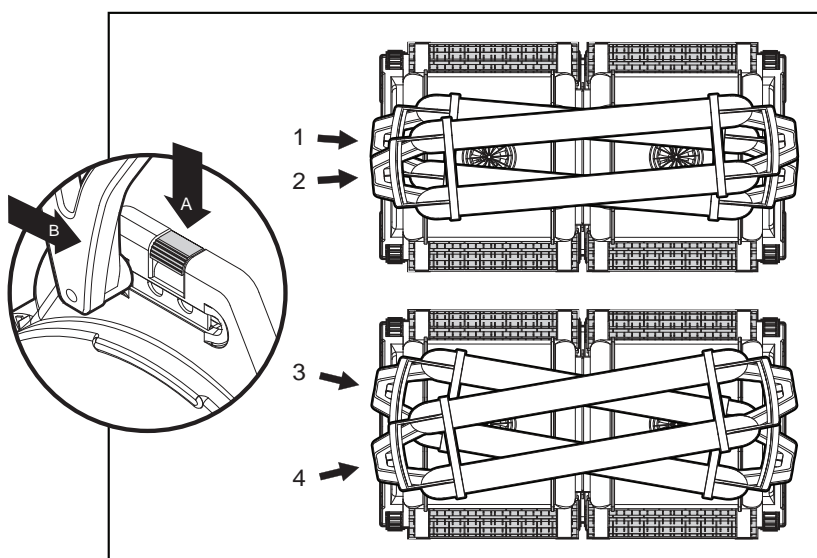

1 - 2 Normale Geschwindigkeit

Bessere Reinigungsleistung an der Wasserlinie.

3 - 4 Hohe Geschwindigkeit

Für schnellere, aber dafür weniger wirksame Reinigungsleistung.

5.2. Einsetzen des Poolreinigers in den Pool

Wenn die Wonder - Bürste/ die Wonder - Ringe trocken sind, tauchen Sie sie in Wasser bis sie weich geworden sind.

Schwenken sie den roboter von seite zu seite oder kippen sie ihn um, um den lufteinschluss zu befreien. Lassen Sie ihn auf den Boden sinken.

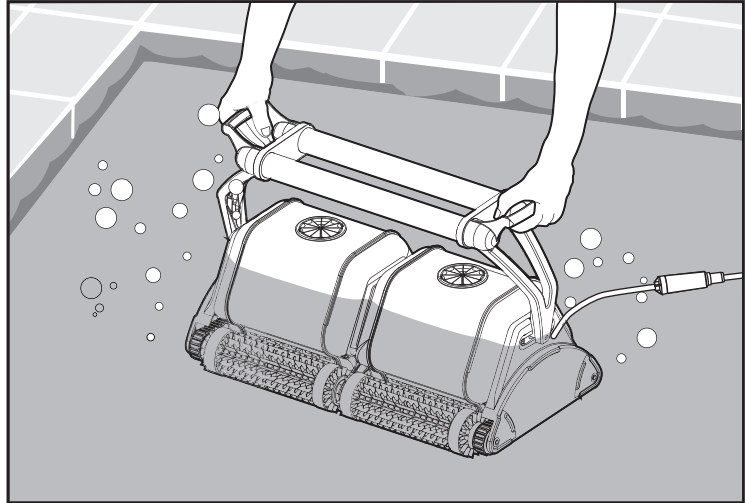

Stellen Sie das Stromversorgungsgerät auf ON.

Der Poolreiniger arbeitet nun, bis er das Ende des Reinigungszyklus erreicht hat.

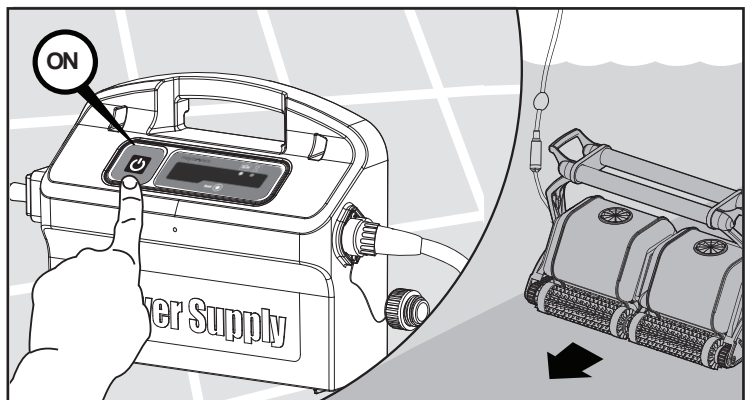

5.3. Entnahme des Poolreinigers aus dem Pool

Der roboter wird am ende des waschzyklus automatisch abschalten.

 Schalten Sie das Gerät AUS und ziehen Sie den Netzstecker.

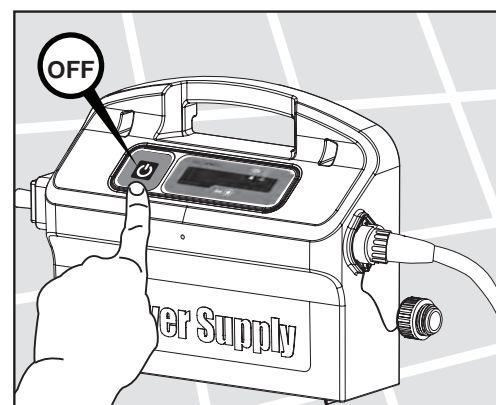

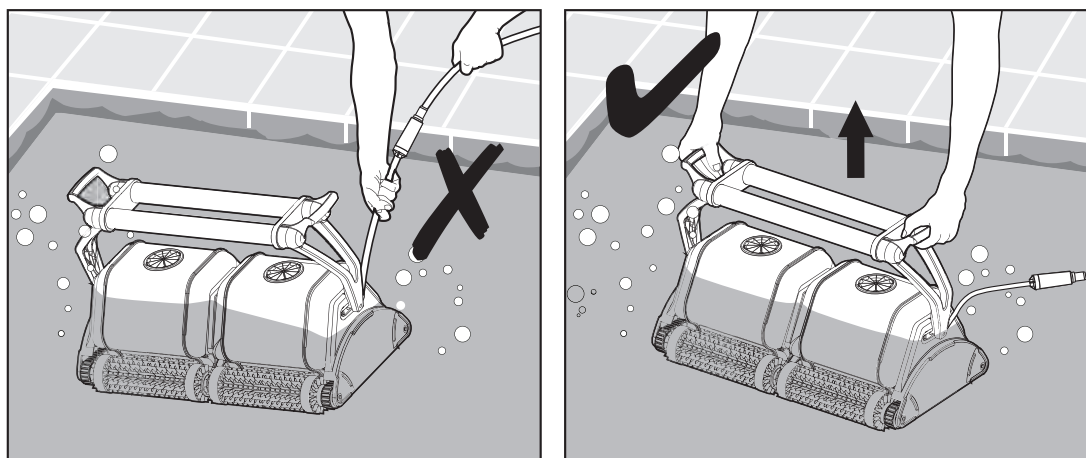

Ziehen Sie den Poolreiniger am Schwimmkabel zum Poolrand.
Ziehen Sie den Poolreiniger am Griff aus dem Pool.

 ZIEHEN SIE DEN POOLREINIGER NICHT AM KABEL AUS DEM POOL.

5.4. Wartung

Reinigen Sie die Filterbeutel mit einem Wasserschlauch. Reinigen Sie die Bürsten regelmäßig mit einem Wasserschlauch. Es ist empfehlenswert, die Filterbeutel regelmäßig in einer Waschmaschine zu waschen. Betätigen Sie ein synthetisches Waschprogramm.

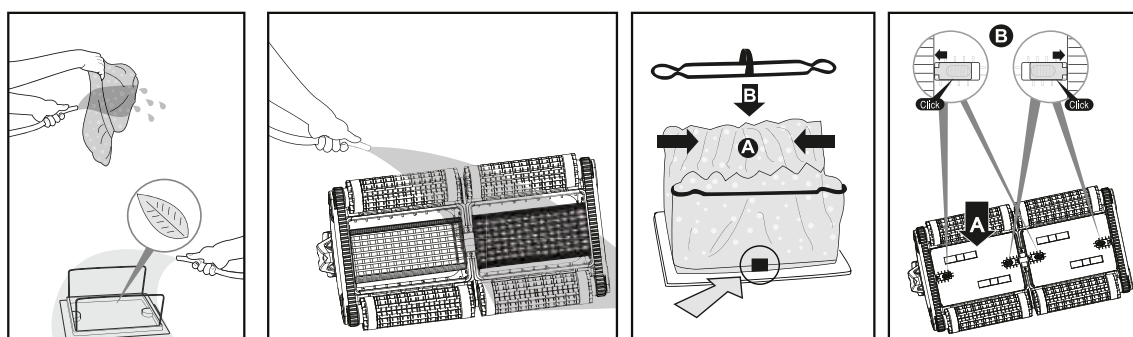
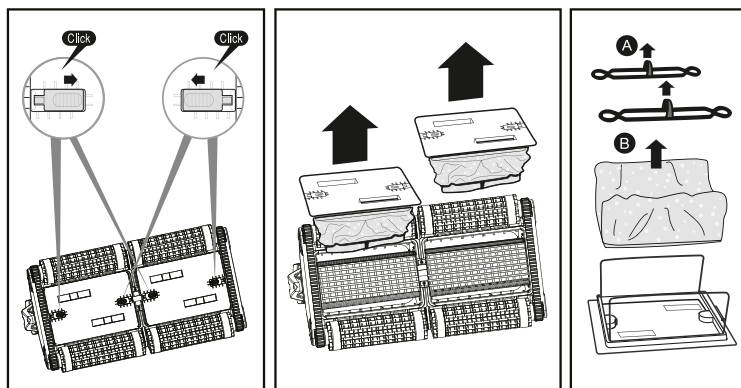

Reinigen des Flügelrades

 Ziehen Sie den Netzstecker.

Wenn Sie Steinchen im Flügelrad bemerken, die sich verklemmt haben, öffnen Sie das Flügelrad und entfernen die Steinchen.

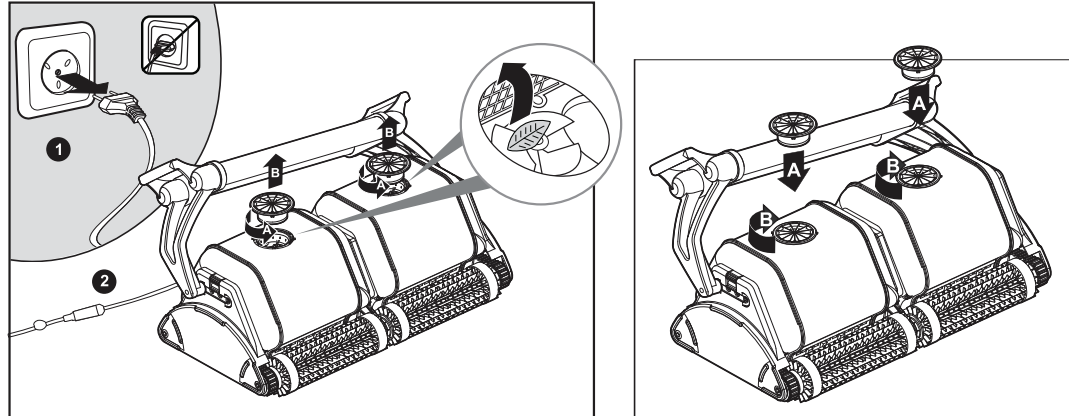

Kabel

Um die Knickstellen zu entfernen, ziehen Sie das Kabel vollständig aus und lassen es für mindestens einen Tag in der Sonne liegen.

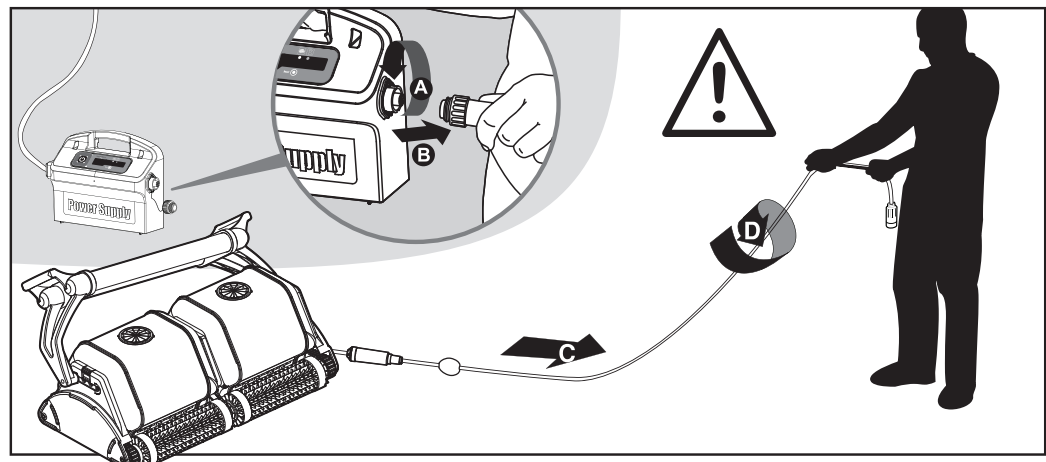

5.5. Lagerung außerhalb der saison

Wenn der Poolreiniger für längere Zeit nicht im Einsatz ist, führen Sie die folgenden Schritte für dessen Lagerung aus:

- Stellen Sie sicher, dass sich kein Wasser mehr im Poolreiniger befindet
- Reinigen Sie gründlich die Filterbeutel und setzen Sie ihn wieder ein
- Rollen Sie das Kabel auf, so dass es nicht geknickt wird, und legen Sie es auf den Caddy
- Lagern Sie den Poolreiniger in einem geschützten Bereich, entweder auf dem dazugehörigen Caddy oder einfach auf dem Kopf stehend

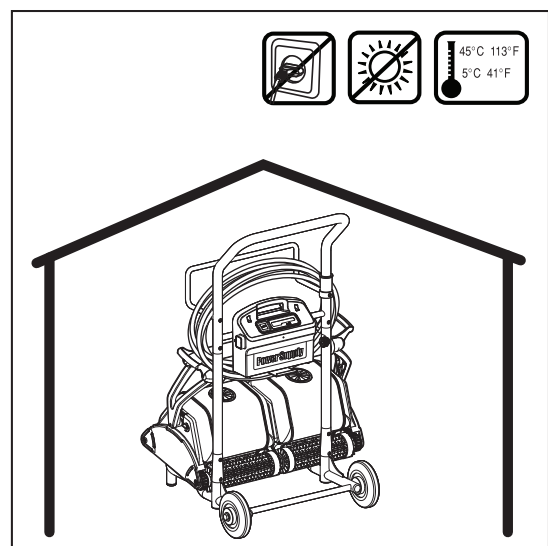

6. STROMVERSORGUNG

Digitale Stromversorgungseinheit mit „Schaltmodus“ mit Anzeige für vollen Filterbeutel und Verzögerungs-Anzeige.

- Eingangsstrom - 100-250 AC Volts
- 50-60 Hertz
- 220 Watt
- Ausgangsstrom - <30 VDC
- IP 54

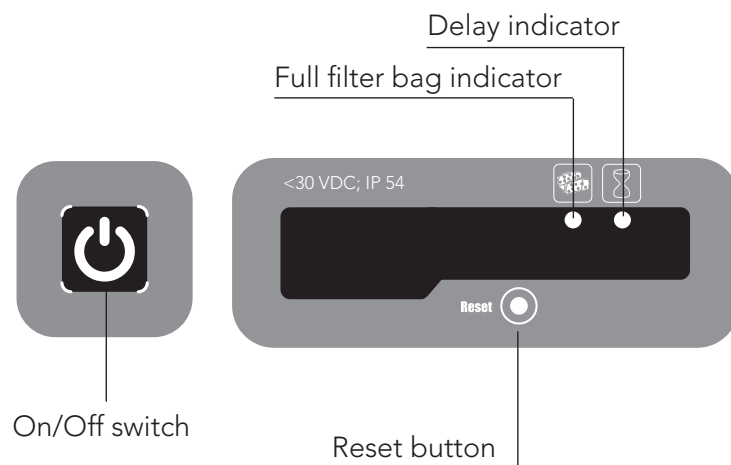
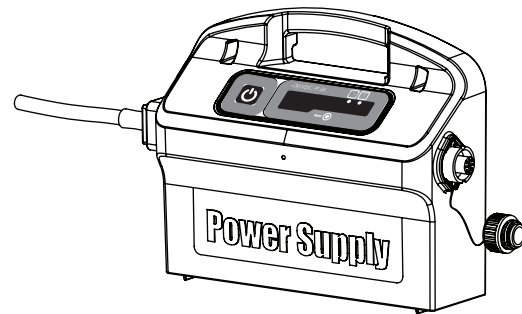

Anzeige für vollen Filterbeutel und Rückstelltaste (Reset)

Die Stromversorgungseinheit ist mit einer Anzeige des Filterbeutelstatus ausgestattet.

Die rote Leuchtdiode zeigt zwei Filterzustände an.

- Wenn sie blinkt – bedeutet dies, dass der Filterbeutel teilweise verstopft ist.
- Wenn Sie aufleuchtet – bedeutet dies, dass der Filter verstopft ist und geleert und gereinigt werden muss.

Wenn die Leuchtdiode sich nicht abschaltet nachdem der Filterbeutel geleert und gereinigt wurde, drücken Sie auf die Rückstelltaste, während der Roboter arbeitet.



Verzögerungsanzeige (Delay)

Die Stromversorgungseinheit ist mit einer Verzögerungsanzeige ausgestattet, die anzeigt, ob die Verzögerungsoption aktiviert wurde oder nicht (über die Fernbedienungseinheit).

7. FERNBEDIENUNGSEINHEIT

Die Fernbedienungseinheit bietet Ihnen zwei Betriebsmoden den automatischen Modus und den manuellen Steuermodus.

Im automatischen Modus können alle Reinigungsparameter geändert werden.

Im manuellen Steuermodus kann die Richtung des Schwimmbadreinigers manuell gesteuert werden.

Das Bedienfeld der Fernbedienungseinheit

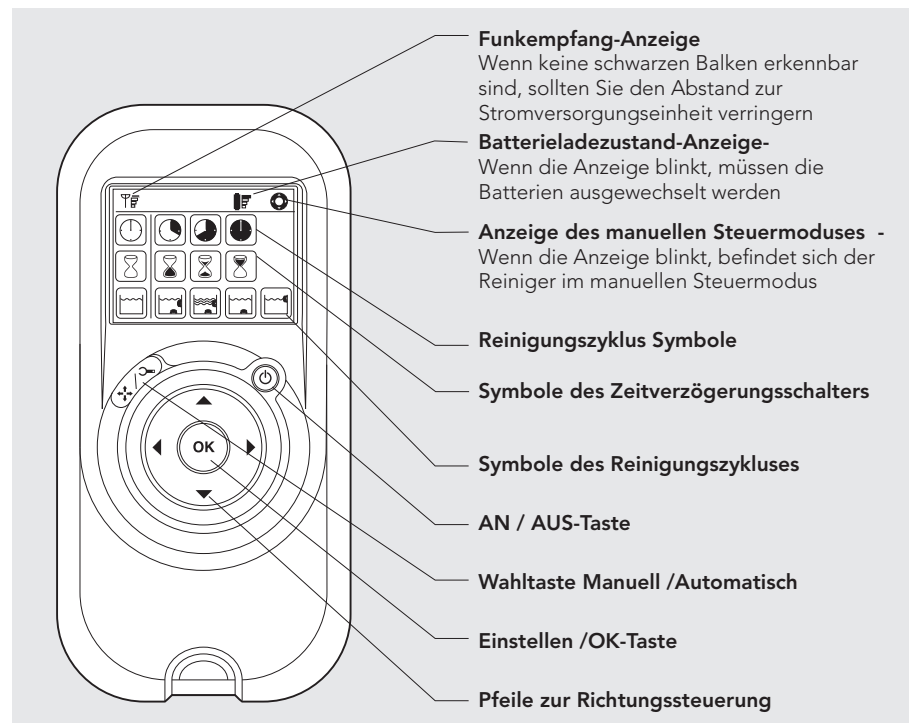













Manueller Steuermodus

<p>An/Aus-Taste</p>	<ol style="list-style-type: none"> 1. Drücken Sie einmal auf die AN/Aus-Taste – die Fernbedienungseinheit schaltet daraufhin in den manuellen Steuermodus. 2. Um die Richtung des Reinigers manuell kontrollieren zu können, müssen Sie die Richtungspfeile benutzen (siehe rechts). 	<p>Richtungspfeile</p>
---------------------	--	------------------------

Verlassen des manuellen Steuermodus und Einstellen des automatischen Moduses

<p>Wahltaste Manuell / Automatisch</p>	<ol style="list-style-type: none"> 1. Drücken Sie einmal auf die Wahltaaste Manuell/Automatisch, um den manuellen Steuermodus zu verlassen. 2. Daraufhin leuchtet der digitale Bildschirm auf und zeigt drei Reihen von Funktionssymbolen in der Standardeinstellung. 	
<p>Richtungspfeile</p>	<ol style="list-style-type: none"> 1. Um die Parameter zu ändern, drücken Sie auf die Pfeile nach oben oder unten. Jetzt können Sie die Parametereinstellungen mit Hilfe der Pfeile nach rechts oder links auswählen. 2. Sobald Sie die gewünschte Funktion erreicht haben, drücken Sie auf die Taste Einstellen/OK. 	<p>Taste Einstellen /OK</p>

Zuerst müssen Sie auf die Wahltaaste Manuell/Automatisch drücken und dann den Modus gemäss folgender Tabelle einstellen:

 <p>Reinigungsmodus-Anzeige Hier können Sie die Reinigungszyklus-Zeit einstellen. Sie können mit Hilfe der RCU zwischen folgenden Optionen wählen.</p>	 <p>Schnell 4 Stunden -Zyklus</p>	 <p>Effizient (Standardeinstellung) 6 Stunden -Zyklus für tagtägliche Benutzung</p>	 <p>Extra 8 Stunden -Zyklus</p>	
 <p>Zeitverzögerungs-Anzeige Hier können Sie festlegen, wann der Schwimmbad-Reiniger mit der Reinigung beginnt. Eine Verzögerung ermöglichtes dem Schmutz, sich auf dem Beckenboden abzusetzen.</p>	 <p>Sofortiger Start (Standardeinstellung)</p>	 <p>Verzögerung von einer Stunde</p>	 <p>Verzögerung von zwei Stunden</p>	
 <p>Anzeige der Reinigungs-Aktivität Ermöglicht Ihnen, eine der folgenden Optionen zu wählen.</p>	 <p>Standard Boden und Wandreinigung (Standardeinstellung)</p>	 <p>Ultra-Sauber Stärkere Saugleistung und langsamere Bewegung. (Boden-und Wände)</p>	 <p>Nur Boden Reinigt nur den Beckenboden und die Wölbung.</p>	 <p>Nur Wände Reinigt die Wände und die Wasserlinie. (Ausser Modell Dolphin 2x2 Gyro)</p>

Hinweis:

- Wenn nach 2 Minuten noch keine Taste gedrückt worden ist, schaltet sich die Fernbedienungseinheit ab und der Schwimmbadreiniger arbeitet weiter mit den vorher eingestellten Einstellungen.
- Wenn die Optionen "Ultra- Sauber" und "Nur Wände" ihren Zyklus beendet haben, kehrt die Schwimmbadreiniger zu den Standardeinstellungen zurück.

PT

Dolphin 2x2 Gyro limpador de piscinas Instruções de operação

Conteúdo

1. INTRODUÇÃO.....	52
2. ESPECIFICAÇÕES.....	52
3. AVISOS E PRECAUÇÕES.....	52
3.1. Avisos.....	52
3.2. Precauções.....	52
4. PEÇAS DO ASPIRADOR DE PISCINA.....	53
5. UTILIZAR O ASPIRADOR DE PISCINA.....	54
5.1. Instalação.....	54
5.2. Colocar o aspirador na piscina.....	55
5.3. Retirar o aspirador da piscina.....	55
5.4. Manutenção.....	56
5.5. Armazenamento fora de época.....	57
6. FONTE DE ALIMENTAÇÃO.....	58
7. CONTROLO REMOTO (RCU).....	59

Dolphin 2x2 Gyro limpador de piscinas

Instruções de operação

1. INTRODUÇÃO

Obrigado por ter adquirido um aspirador de piscina robótico da Maytronics.

Temos a certeza que o seu aspirador de piscina robótico da Maytronics lhe irá proporcionar uma limpeza fiável, conveniente e eficiente da sua piscina. A sua filtração fiável em todas as condições da piscina, escovação ativa e a escova de ascensão para todas as superfícies melhoram a higiene da piscina ao máximo.

Os aspiradores de piscina robóticos da Maytronics proporcionam uma tecnologia de limpeza avançada, desempenho de longa duração e fácil manutenção. Você e a sua família terão toda a liberdade para desfrutar uma natação com plena confiança de que a sua piscina está completamente limpa.

2. ESPECIFICAÇÕES

Proteção del motor: IP 68

Profundidade mínimo: 0,80 m/ 2,6 ft

Profundidade máximo: 5,00 m/ 16,4 ft

3. AVISOS E PRECAUÇÕES



3.1. Avisos

- Utilize apenas a fonte de alimentação fornecida (original)
- Certifique-se de que a tomada elétrica está protegida por um interruptor de falta de terra ou um interruptor de fuga à terra
- Mantenha a fonte de alimentação fora das poças de água
- Coloque a fonte de alimentação pelo menos a 3 m /10 ft da borda da piscina
- Não entre na piscina enquanto o aspirador de piscina estiver a funcionar
- Desligue a fonte de alimentação da tomada antes de qualquer atividade de manutenção

3.2. Precauções

Quando não estiver a utilizar o aspirador de piscina, guarde-o no Caddy, numa zona de sombra. Use o aspirador de piscina apenas nas seguintes condições de água:

Cloro:	Máx. 4 ppm
pH	7,0 – 7,8
Temperatura:	6–34 °C (43–93 °F)
NaCl	Máximo = 5000 ppm

4. PEÇAS DO ASPIRADOR DE PISCINA



Escovas combinadas
Escova que limpa todas as superfícies, ideal para a maioria das piscinas

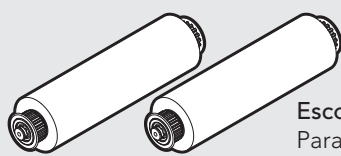

(opcional)

Escovas Wonder (espuma)
Para cerâmica lisa

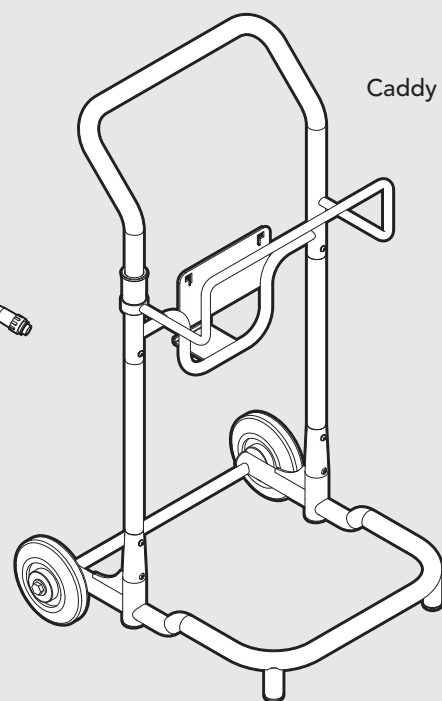

Caddy

Tampa inferior e sacos de filtro

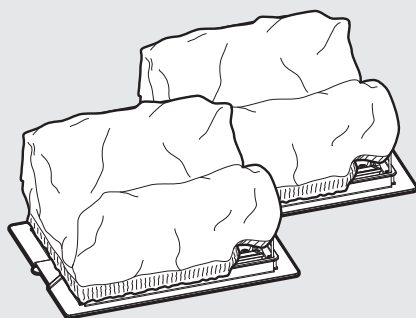

Opções do saco do filtro:
Fino - predeterminado
Ultra fino - extra



Controlo Remoto

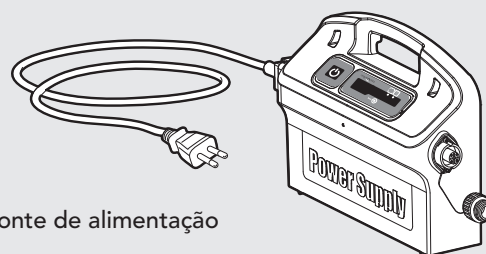

Fonte de alimentação

5. UTILIZAR O ASPIRADOR DE PISCINA

5.1. Instalação

Coloque a fonte de alimentação aproximadamente no meio do lado maior da piscina a uma distância de 3 m/10 ft.

Ligue o cabo flutuante à fonte de alimentação inserindo-o com o entalhe no conector (1) alinhado com a ranhura na tomada da fonte de alimentação e girando no sentido horário (2).

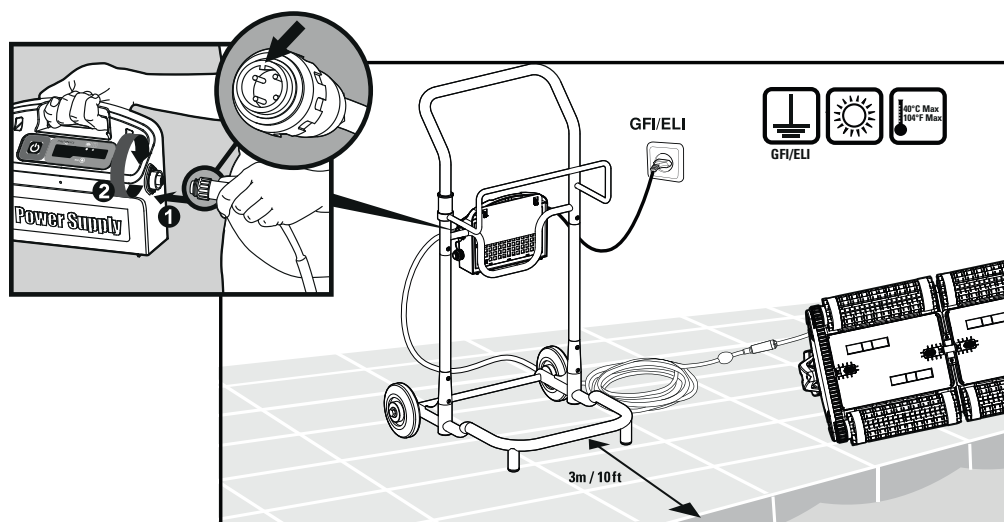

Mude a posição diagonal da alça para movimento lateral da linha de flutuação.

Para ajustar o ângulo da alça:

A. Pressione a trava para baixo e segure-a nesta posição.

B. Mova a alça para a posição desejada e solte a trava para manter a alça no lugar.

1 - 2 Progressão Normal

Limpeza mais eficiente na linha de água.

3 - 4 Progressão Rápida

Velocidade rápida – Para uma ação de limpeza mais rápida, mas menos eficiente na linha de água.

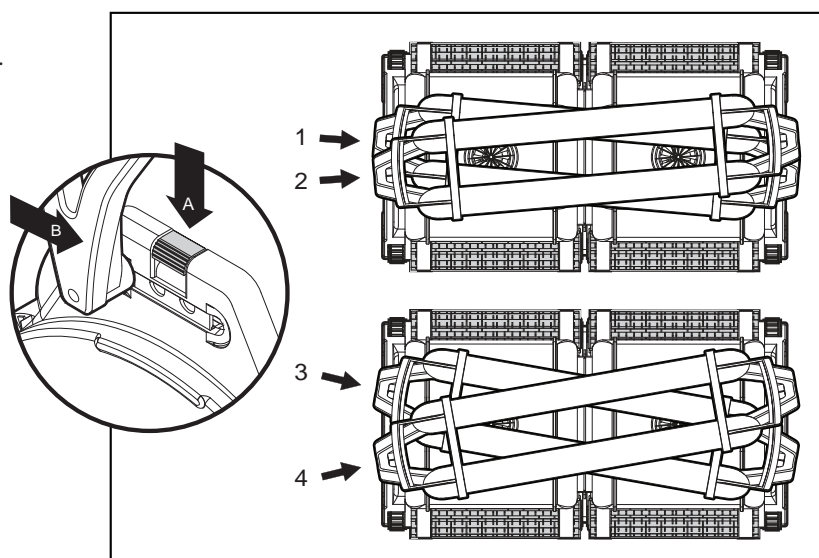

5.2. Colocar o aspirador na piscina

Se a escova Wonder / anéis Wonder estiverem secos, mergulhe-os em água até amaciarem.

Sacudir o robô lateralmente ou virar de cima para baixo para liberar ar confinado. Deixe-o afundar até ao fundo da piscina.

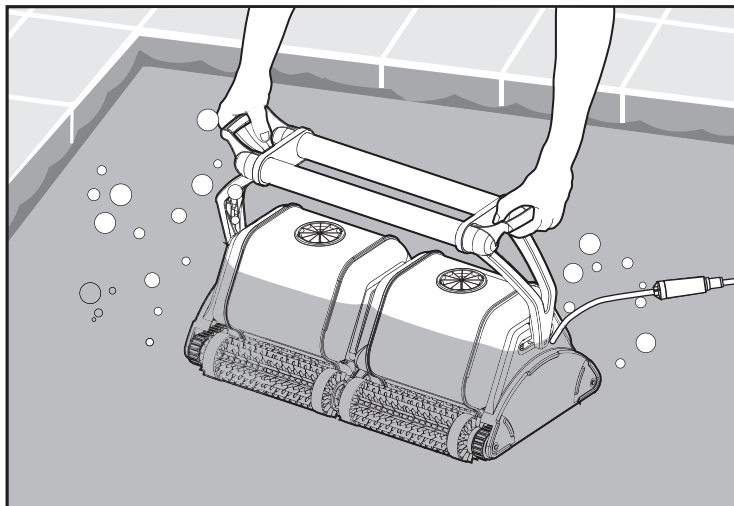

Ligue (ON) a fonte de alimentação.
O aspirador de piscina não irá funcionar até que tenha alcançado o fim do ciclo de limpeza.

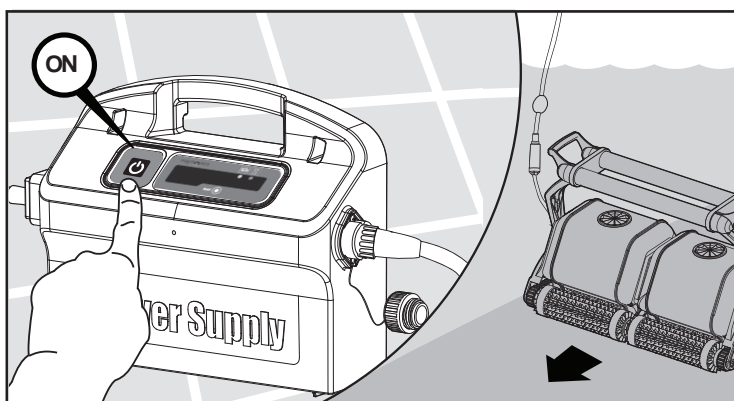

5.3. Retirar o aspirador da piscina

O robô desligará automaticamente no fim do ciclo de limpeza.

 Desligue (OFF) e retire a ficha da fonte de alimentação.

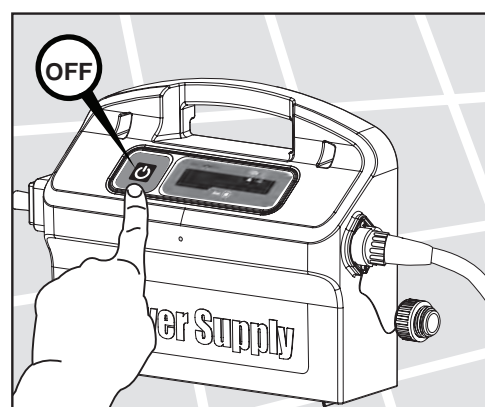

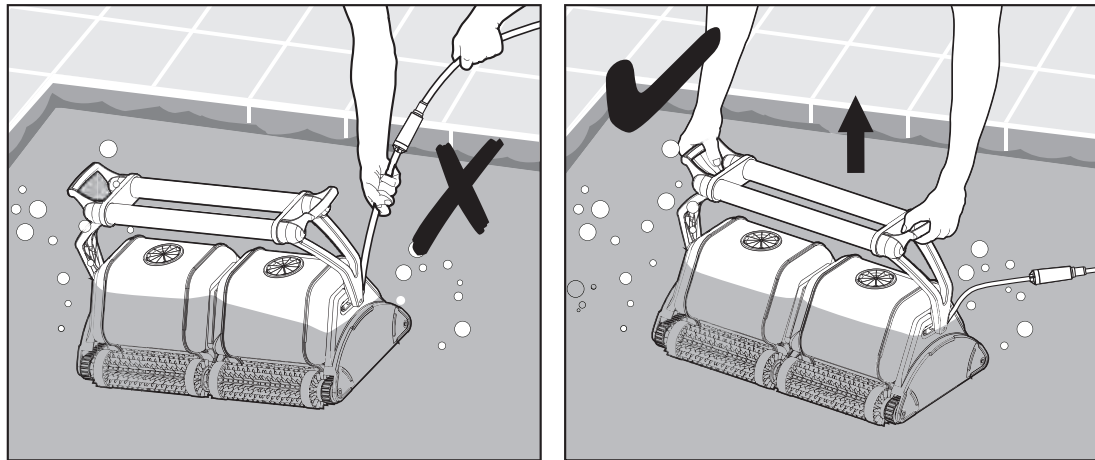

Utilizando o cabo flutuante, traga o aspirador até à borda da piscina.

Utilizando a asa, retire o aspirador da piscina.

! NÃO RETIRE O ASPIRADOR DA PISCINA UTILIZANDO O CABO.

5.4. Manutenção

Limpe os sacos de filtro com uma mangueira. Limpar periodicamente as escovas com uma mangueira.

Recomenda-se lavar periodicamente os sacos de filtragem em uma máquina de lavar.

Utilize o programa de limpeza sintética.

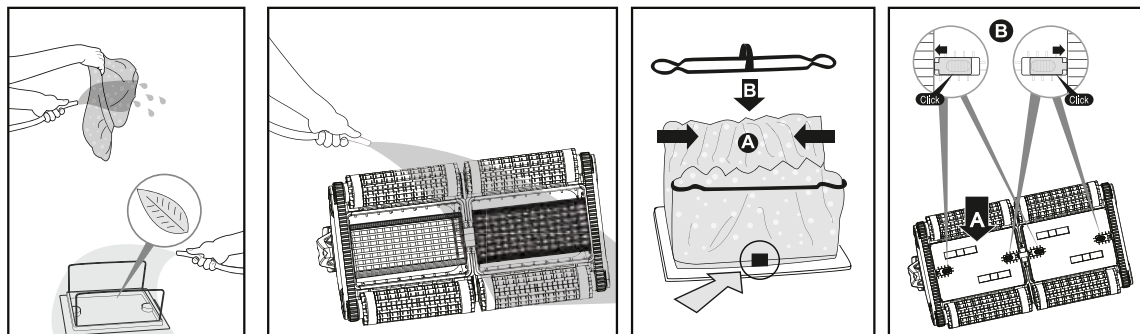
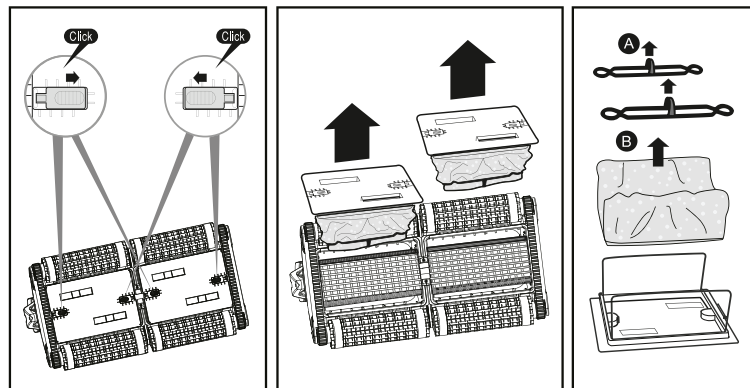

Limpeza do impulsor

 **Desligue a fonte de alimentação da tomada.**

Se observar detritos presos no impulsor, abra-o e remova os detritos.

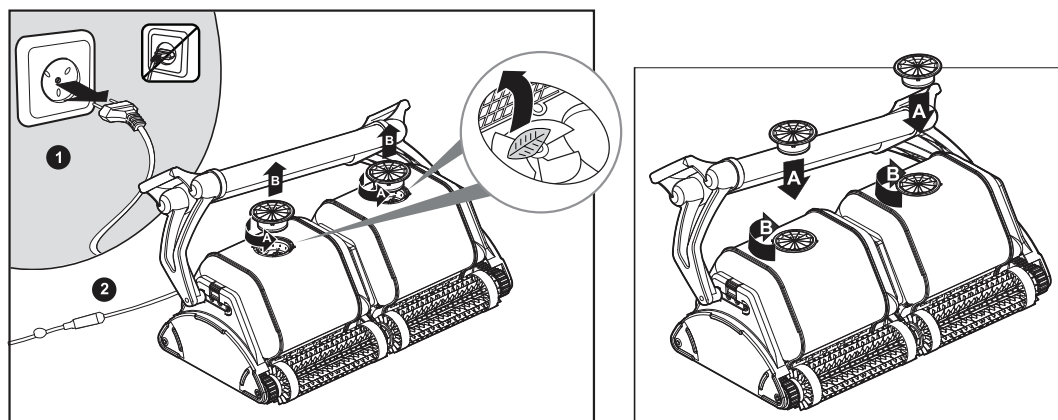

Cabo

Para remover os torções deve esticar o cabo completamente e deixá-lo exposto ao sol por pelo menos um dia.

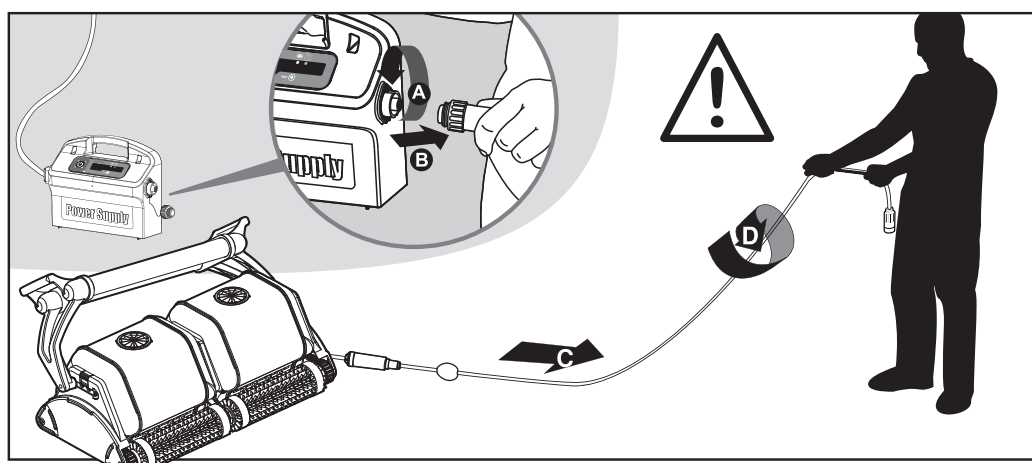

5.5. Armazenamento fora de época

Se o aspirador de piscina não for utilizado por um longo período, execute as seguintes fases de armazenamento:

- Certifique-se que não permanece nenhuma água no aspirador de piscina
- Limpe cuidadosamente os sacos de filtro e insira-o na sua posição
- Enrole o cabo de modo a que fique sem torções e coloque-o sobre o Caddy
- Armazene o aspirador de piscina numa área protegida, no seu Caddy ou simplesmente virado ao contrário

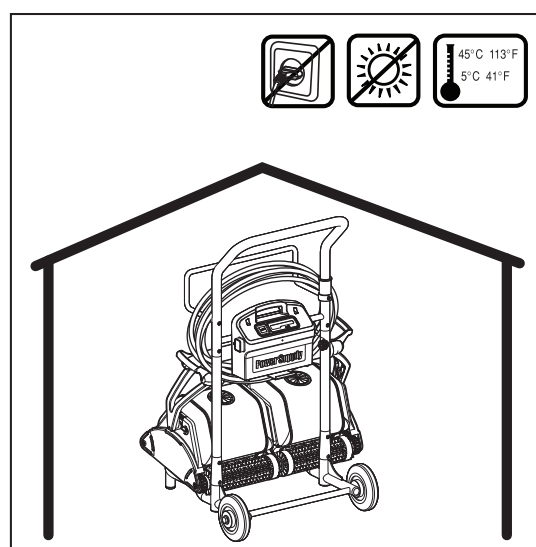

6. FONTE DE ALIMENTAÇÃO

Fonte de Alimentação com Modo de Câmbio Digital, com bolso de filtro cheio e indicador de atraso.

- Entrada - 100-250 AC Volts
- 50-60 Hertz
- 220 Watt
- Saída - <30 VDC
- IP 54

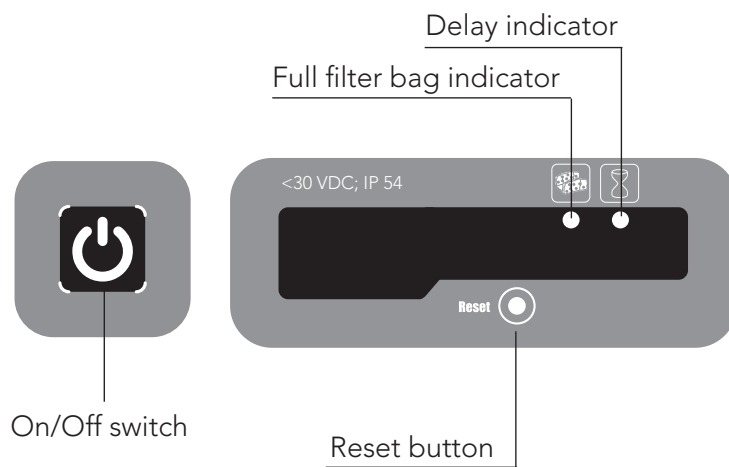
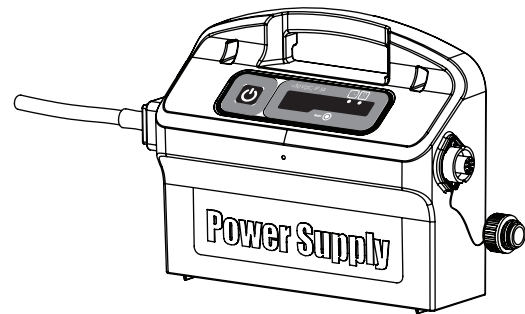

Indicador do saco de filtro cheio e botão Reset

A fonte de alimentação é equipada com um indicador do estado do saco do filtro.

O LED vermelho indica duas condições do filtro.

- Quando está piscando – o saco do filtro está parcialmente bloqueado.
- Quando está aceso – o filtro está bloqueado e deve ser esvaziado e limpo.

Se o LED não se apaga depois do saco de filtro ter sido esvaziado e limpo, pressione o botão Reset enquanto o robô estiver funcionando.



Indicador de atraso (Delay)

A fonte de alimentação está equipada com um indicador de atraso que indica se a opção de atraso está ativada (através da unidade de controle remoto).

7. CONTROLO REMOTO (RCU)

O Painel de Controlo da Unidade de Controlo Remoto

A RCU oferece dois modos de operação – Modo Automático e Modo Manual de Controlo de direcção.

No modo Automático, todos os parâmetros de limpeza podem ser modificados.

No modo Manual de direcção, a direcção do Limpador de Piscinas pode ser controlada manualmente.

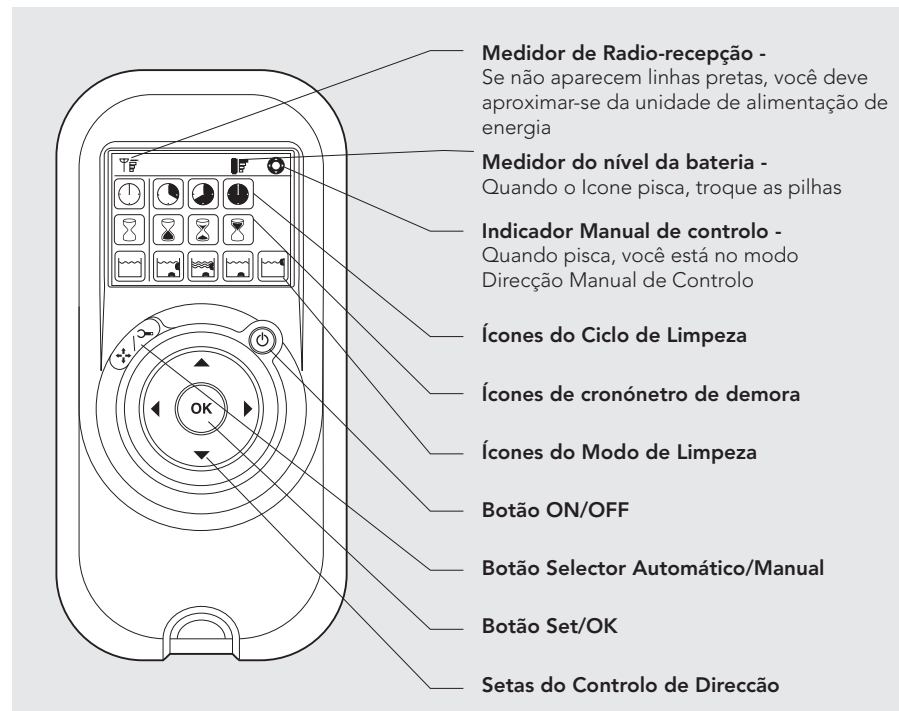

Modo Manual de Controlo de Direcção

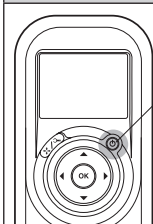

Botão On/Off

1. Pressione o botão ON/OFF uma vez - A RCU iniciará no modo Manual de Controlo de Direcção.
2. Para controlar manualmente a direcção do limpador, use as setas de controlo de direcção (ver à direita).

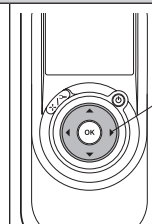

Setas de Controlo de Direcção

Sair do Modo Manual de Controlo de Direcção e Configurar o Modo Automático

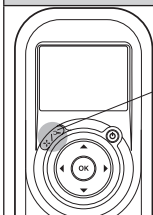

Botão de Seleção Manual / Automático

1. Para sair do modo Manual de controlo de direcção, pressione o botão de Seleção Manual/Automático apenas UMA VEZ.
2. O ecrã digital ilumina-se e três linhas de ícones de função aparecem no modo pré-determinado.

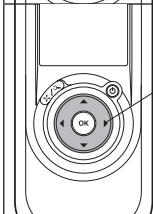
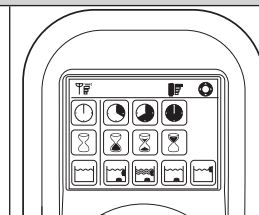





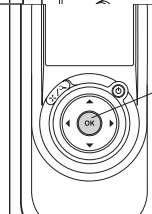







Setas de controlo de Direcção

1. Para modificar os parâmetros pressione as setas para cima e para baixo. Para escolher a configuração dos parâmetros, use as setas da direita ou da esquerda.
2. Quando obtiver a função desejada, pressione o botão Set/OK.



Botão Set/OK

Primeiro pressione o botão de selecção Manual/Automático, depois configure de acordo com a tabela seguinte:

 <p>Indicador do Ciclo de Limpeza Este determina o tempo do ciclo de limpeza. A RCU permite escolher entre as opções seguintes.</p>	 <p>Rápido Ciclo de 4 horas</p>	 <p>Eficiente (Configuração prédefinida) Ciclo de 6 horas para uso diário</p>	 <p>Extra Ciclo de 8 horas</p>	
 <p>Indicador do Tempo de Início Retardado Este determina quando o limpador de piscina começa a operar. Um início retardado permite que a sujidade se deposite no fundo da piscina.</p>	 <p>Início imediato (Configuração prédefinida)</p>	 <p>Início Retardado em Uma Hora</p>	 <p>Início Retardado em Duas Horas</p>	
 <p>Indicador da Acção de Limpeza Permite a escolha entre as opções seguintes.</p>	 <p>Padrão Limpeza de piso e parede. (Configuração prédefinida)</p>	 <p>Ultra-limpo Maior sucção e movimento mais lento. (piso e parede)</p>	 <p>Somente Piso Limpa somente o piso e as cavidades</p>	 <p>Somente Paredes Limpa somente as paredes e a linha de água. (Exceto o modelo Dolphin 2x2 Gyro)</p>

Nota:

- Depois de decorridos 2 minutos, se nenhum botão for pressionado, a Unidade de Controlo Remoto desliga-se e o Limpador de Piscina continua a operar na configuração anterior.
- Quando as opções "Ultra-Limpo" e "Somente Paredes" concluem os seus ciclos, a Limpador de Piscina retorna à configuração pré-estabelecida.

Per maggiori informazioni potete visitare il sito web
www.robotpiscinakaptur.it

oppure

contattare il nostro servizio di assistenza clienti:

New Pool Srl

Via N. Sauro, 12 - 20862 Arcore (MB)

Email: info@newpool.it

Telefono: +39 039 617842